

Eleventh Year of Service

# RADIO ENGINEERING

Vol. XI

MARCH, 1931

No. 3

## IN THIS ISSUE

■■■■■■■■■■

BIAS DETECTOR OVERLOAD

By J. R. Nelson

DESIGN TESTS FOR AMPLIFIERS AND COMPLETE  
RADIO RECEIVERS

By Sylvan Harris

DEVELOPMENTS IN THE ART OF TELEGRAPHY

By Major R. B. Steele

R. M. A. SHOW

Sold only by subscription  
\$2.00 per year



*The Journal of the Radio Industry*

# What tube engineers say about Cenco Hypervac pumps

*“have lowest operating cost...*

*the most efficient”*

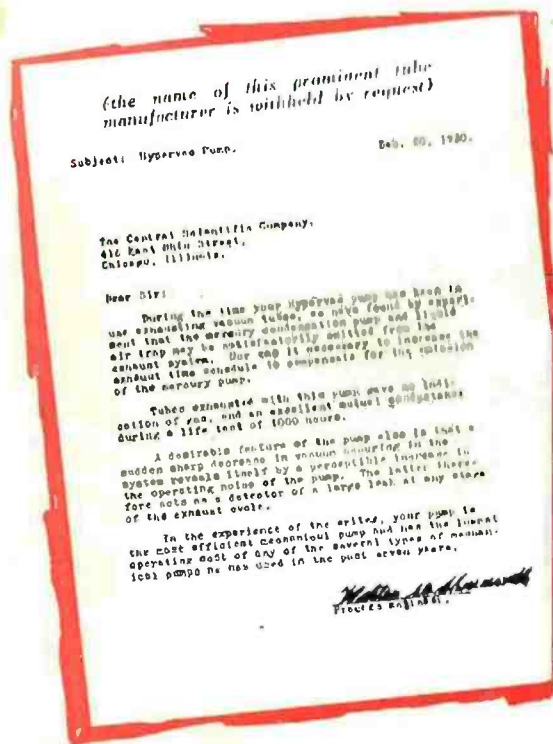
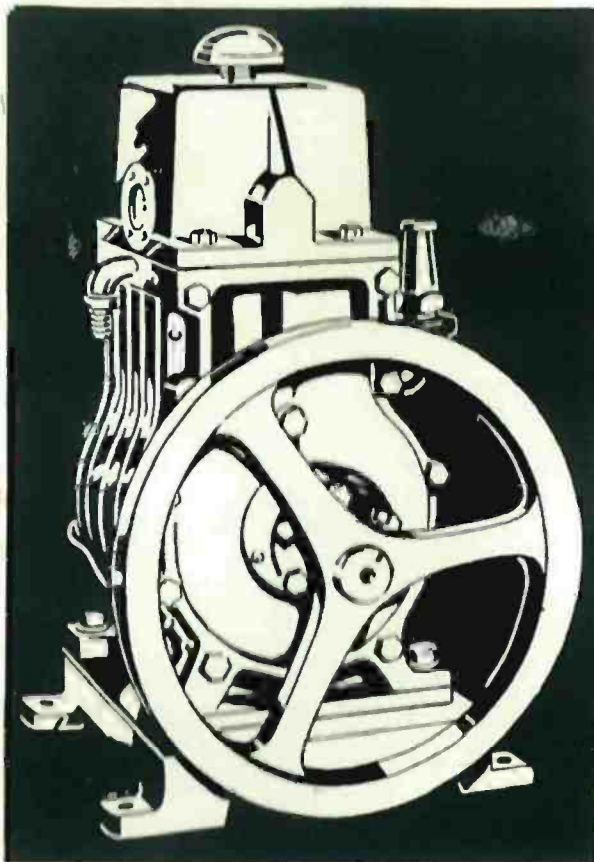

Radio tube engineers who know the keen necessity of good exhaustion are finding totally new possibilities in the Cenco Hypervac pump. Reports from tests everywhere confirm its supreme performance under service conditions.

They say it has remarkably better speed and recovers instantly on automatic machines . . . that mercury pumps are a waste of space when the Hypervac is put on hand stations . . . that tubes pumped by Hypervacs pass the severest life tests with perfect records. There are four new design principles back of this exceptional capacity for radio tube exhaust.

For details address, Central Scientific Company, 460 E. Ohio St., Chicago.

**CENTRAL SCIENTIFIC COMPANY**  
**CENCO HIGH VACUUM PUMPS**  
 Hyvac Megavac Super vac Rotovac Hypervac  
 NEW YORK - BOSTON - CHICAGO - TORONTO - LOS ANGELES

# DEPENDABLE INSULATION

## *accurately* FABRICATED

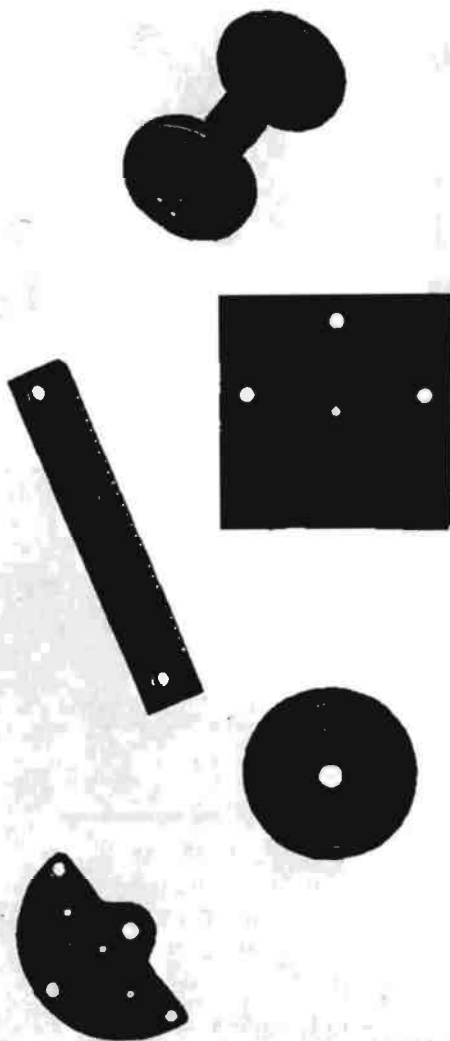

**F**ORMICA is dependable, uniform, high quality material made in numerous grades and shapes to meet all of the requirements of the electrical and radio industries.

For 18 years it has been a standard material in the field—used by some of the leading American technical organizations.

The largest producing and fabricating equipment in the industry is available to give prompt service.

Location near the center of industry makes quick delivery possible over the shortest average haul.

THE FORMICA INSULATION CO.  
4638 Spring Grove Avenue  
Cincinnati, Ohio





# RADIO ENGINEERING

Reg. U. S. Patent Office

Member, Audit Bureau of Circulations

Western Editor  
ULMER G. TURNER

Editor  
DONALD MCNICOL

Managing Editor  
F. WALEN

Vol. XI

MARCH, 1931

Number 3

## Contents

	PAGE
EDITORIAL .....	4
IMPRESSIONS AND EXPRESSIONS <i>By Austin C. Lescarboura</i>	18
BIAS DETECTOR OVERLOAD .....	21
<i>By J. R. Nelson</i>	
NEW COMBINATION EQUIPMENT FOR YACHTS AND CRUISERS .....	24
DESIGN TESTS FOR AMPLIFIERS AND COMPLETE RADIO RECEIVERS .....	25
<i>By Sylvan Harris</i>	
ACCURACY OF MEASURING INSTRUMENTS <i>By A. J. Lush</i>	28
FEDERAL RADIO COMMISSION ISSUES NEW ORDERS .....	29
WORLD MARKET FOR RADIO EQUIPMENT .....	31
WHAT SHALL WE DO FOR 1931 SETS? <i>By Austin C. Lescarboura</i>	32
DEVELOPMENTS IN THE ART OF TELEGRAPHY <i>By R. B. Steele</i>	35
HOME RECORDING TO THE FORE <i>By Austin C. Lescarboura</i>	43
R. M. A. SHOW .....	44
TELEVISION FOR THE EXPERIMENTER <i>By C. Bradner Brown</i>	45

## Departments

NEWS OF THE INDUSTRY .....	50
NEW DEVELOPMENTS OF THE MONTH .....	53
INDEX OF ADVERTISERS .....	68



MORRIS METCALF, President of the R. M. A., writes a message to the members of the Association. He says:

"Recently one of America's greatest newspapers carried a story through an entire column, relating the wonders of radio and the story of two engineers who believe that some day a certain type of radio tube may bring back the scenes of past generations, such as the civil war and other historical events.

"Even a radio enthusiast would have to stretch his imagination pretty hard to look ahead to such an achievement, but this story definitely establishes one dominant fact; that radio is ever new, ever news, and ever of interest to the American public!

"In the year just begun, the subject is even crisper, fresher, than at any time since radio first startled the world. The interest is deeper, sounder, surer. As an integral part of the daily lives of the people of this nation, whatever radio has to promise is of concern. And no one is a keener judge of this news value than editors of the above mentioned newspaper.

"1931 is to be the year of re-awakening. A re-awakening of sales and profits and progress!"

(Signed) MORRIS METCALF,  
President.



BRYAN S. DAVIS  
President

JAS. A. WALKER  
Secretary

Published Monthly by

Bryan Davis Publishing Co., Inc.  
52 Vanderbilt Ave.  
New York City

E. M. BACON  
Advertising Manager

J. E. NIEMEN  
Circulation Manager

Publication Office—North Broadway, Albany, New York  
Chicago Office—333 N. Michigan Ave.—Charles H. Farrell, Mgr.  
St. Louis Office—505 Star Building—F. J. Wright

Kansas City Office—306 Coca Cola Building—H. W. Mitchell  
San Francisco Office—155 Sansome St.—R. J. Birch  
Los Angeles Office—846 S. Broadway—R. J. Birch

Entered as second class matter at the post office at Albany, N. Y., January 9, 1925, under the act of March 3, 1879. Yearly subscription rate \$2.00 in U. S. and Canada; \$3.00 in foreign countries.

**ANNOUNCING!**

*Type K*  
**Metallized Filament**

this company's greatest  
contribution to the radio  
and vacuum tube industries  
since the introduction of

**IRC**

*Metallized*

**RESISTORS**

Engineering data supplied on request.

INTERNATIONAL RESISTANCE COMPANY, PHILADELPHIA

Also makers of Precision Wire Wound Resistors



# E d i t o r i a l

MARCH, 1931

## THE TUBE AND COM- MUNICATION

IT WAS the actual experiments of G. O. Squier and E. R. Cram, in 1910, over a wire of the Postal Telegraph-Cable Company between Baltimore, Maryland, and New York, that attracted the attention of communication engineers to the possibilities of "wired wireless" or "carrier current" signaling. A year later the four U. S. patents issued to General Squier covering his developments were dedicated by him to the American public.

It was not until the close of the War that the full potentialities of the vacuum tube became available for other than war needs. It will be recalled that it was just before the War started that the regenerative and amplifying qualities of the tube were discovered.

With oscillating and amplifying tubes at hand the principles of Squier's superposed circuits became applicable on a commercial scale. In 1920 practical demonstrations of Squier's wired wireless system were made on telegraph lines of the New York Central Railroad.

Also, the American Telephone and Telegraph Company made extensive use of the system on its lines throughout the country; adding many refinements and perfecting the details of operation.

The two American large telegraph companies so far have not made much use of carrier current signaling over their own wires; relying mainly upon multiplex printing telegraph operation. In Canada, however, the Canadian National Telegraphs have installed an extensive system of carrier current signaling. It is reported also that the opposition Canadian company, the C.P.R. Telegraphs, contemplates similar use of a carrier current system.

The interesting paper read recently by Major Steele before the Radio Club of America, New York, and published in this issue of RADIO ENGINEERING, presents the subject in a manner intelligible to engineers familiar with vacuum tube circuits.

The wide application of the vacuum tube in wire telegraph and wire telephone services marks the drawing together of the engineering of radio and wire line practice. The communication engineer of the present and the future must of necessity keep abreast of advancement in the technic of vacuum tubes and their related circuits.

## ECHO SIGNALS

THE use of super-sensitive radio signal indicating recorders has made possible further study of the so-called echo signals. Occasionally investigators who have stable reputations as scientists are quoted in the daily press as having reported reception of vagrant, unidentifiable radio signals, which, because of their characteristics, are believed to have originated at organized radio transmitters. These experiences are aside from the data gathered in regard to signals which "go all the way around" the earth, and those which "go around both ways."

Radio transmission phenomena involve a large number of complex considerations. In the case of broadcast reception with average broadcast receivers, transmitting antenna watts, and millivolts per meter in the receiving antenna or loop, continue as the practical, if rough, factors of every day calculation. All of the remaining factors which have a bearing upon distance, and upon continuity of reception from given transmitters may continue of little concern in the broadcast field so long as increased power in transmitting antennas serves to override their effects upon transmission and reception.

Engineers concerned with the problems of long distance short-wave radio working cannot dismiss the meteorological factors of transmission. Thus, throughout the world much is being learned about governing factors other than kilowatts in the transmitting antenna.

P. O. Pedersen, in Denmark, continues to observe and to report the results of his investigations. Recently Pederson noted that a test signal was not received at observing station until 195 seconds had elapsed. Still another did not register until 260 seconds had passed. This phenomenon is associated with upper reflecting surfaces. A signal circles the earth in about one-seventh second. A signal traveling to the sun and back would require seventeen minutes; to mars and back about six minutes and to the Moon and back, two and two-thirds seconds. As convex surfaces would not be viewed as effective reflectors the thought is presented that beyond the Kennelly-Heaviside layer there are one or more concave reflecting shells that are due for further study.

*Donald Mc Nicol*  
Editor.

# Scientists study effect of *Vibration* on fastening devices

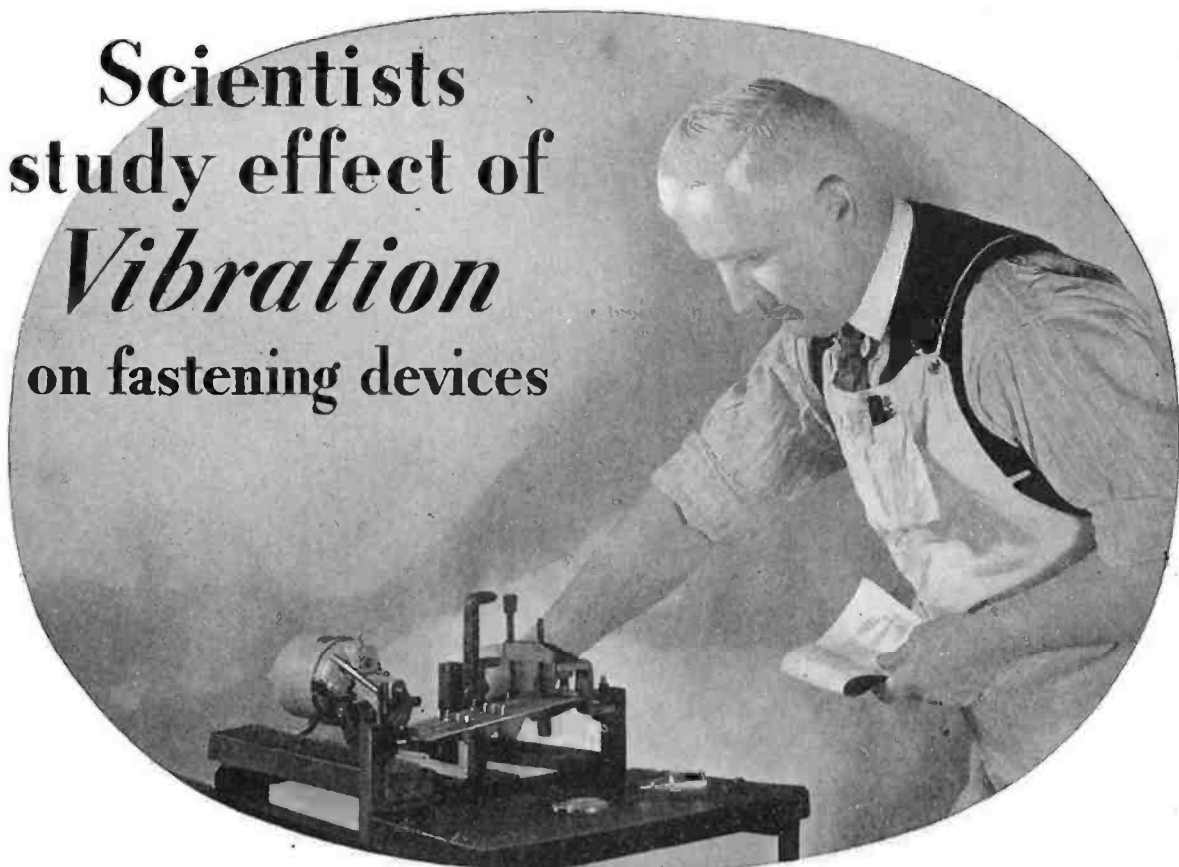

*"It is evident that fastenings made with Self-tapping Screws will resist vibration much better than machine screws"* say authorities of the COLLEGE OF ENGINEERING OF N. Y. U. after tests.

FOR weeks scientists of the College of Engineering of New York University studied the holding power of fastening devices. By unbiased tests they were to determine whether Self-tapping Screws, noted for economy in assembly work, have greater or less holding power than the fastening devices they usually replace.

Particular attention was given to the effect of vibration, for it is the chief cause of fastening failure. The specially constructed vibrating machine, shown above, was run more than a hundred hours under close observation. Four test specimens were subjected to the vibration—each specimen containing two sizes of Self-tapping Screws, and an equal number of the equivalent sizes of machine screws, the most common alternative means of fastening.

Early in the test the majority of the fastenings made with machine screws failed. *Yet not a single Self-tapping Screw loosened.* The report of the authorities conducting the test states:—"It is evident that Parker-Kalon Hardened Self-tapping Screws will resist vibration much better than the conventional machine screw".

Detailed information developed from the extensive tests made at N. Y. U. of the comparative strength of fastening devices under stresses of vibration, tension and shear will be found in the booklet offered here. The coupon brings it, free; with another helpful booklet showing the large savings gained on metal assemblies through the use of these unique Screws that eliminate tapping, fumbling with bolts and nuts and other fastening difficulties.



PARKER-KALON CORPORATION  
Dept. L, 190-198 Varick Street, New York, N. Y.  
Send me free booklets on the Security and Economy of assemblies made with Self-tapping Screws.

Name and Co. ....  
Address .....



**PARKER-KALON**  
HARDENED  
**Self-tapping Screws**

MADE IN U.S. AND FOREIGN COUNTRIES

*"Distributors Serve Industry Economically"*

# Smooth, Noiseless

The new Frost-Radio No. 20 Series Wire-Wound Volume Controls are the result of eleven years of manufacturing experience and research, and represent the very highest development we have yet seen in *smooth, noiseless action*. The high degree of perfection we have achieved is due to the new Frost-Radio variable contacting member. (*We found that over 95% of noisy wire-wound volume controls owed their imperfect operation to poor contacting between the movable contactor and the resistance element.*)

The variable contactor used in our No. 20 Series makes two separate and distinct contacts with the resistance element.

These contacts are not *point* contacts, but *line* contacts, and there are two of them, each of which is  $3/32''$  in length, or a *total line contact of  $3/16''$* . This is accomplished by having the contactor made in the form of a shoe with two runners, each  $3/32''$  in width. The raceway for one of these runners is just below the top of the resistance strip — for the other just above the bottom of the strip. As the runners are in vertical alignment with each other both can make contact with the same turn of wire simultaneously. However, when such a condition exists and the arm is moved slightly, one runner, due to the pitch of the winding, makes contact with the next turn of wire *one-half turn ahead of the other runner*. It will be seen that this cuts down the resistance steps to one-half the resistance of one turn of wire, giving the same result as though the winding strip contained twice as many turns of wire. It will be obvious that as the contactor travels from turn to turn of the winding, the smaller the resistance steps are, the more noiseless will be the operation of the control. Every fraction of an inch that can be added to the effective length of the resistance element improves both the quality and the durability of the control, as it then becomes possible to

*employ more turns and larger wire.* To obtain the maximum number of turns of wire on our strips we utilize the smallest possible spacing between turns that will give the required resistance value. For example, on a strip wound with  $.002''$  wire, there is but one ten-thousandth of an inch between turns. Such a strip has 466 turns of wire per linear inch of wound strip. With the conventional type of contactor, variations in the height of the adjacent turns of wire no greater than five ten-thousandths of an inch higher or lower than adjoining turns will produce serious

noise. A study of the contacting runners of the No. 20 Series Controls will reveal that they are *pulled* along their raceways with an action similar to drawing a sled. This action is reversible, so that the runners are never pushed. As the spring tension is applied midway between the two runners, equalization of pressure is automatically effected by the compression type helical spring. Further study will show that by contacting on the *inside* of the strip these runners have an area in contact with the wire that is many times greater than is possible when contacting on the edge of the strip in the conventional manner.

This enables us to reduce the contact pressure per square inch of area to a mere fraction of what has been past practice, and at the same time utilize a contact pressure several times greater than that employed in old style rheostats. This reduces the danger of cutting and scoring between the contactor and wires to a negligible quantity, and at the same time attains a lower contact resistance than has ever before been possible in commercial units of this class.

Dirt, fragments of metal, or other foreign bodies on the raceway of one runner cannot prevent the other runner from making positive contact with the element less than one-half a turn of wire away from the point where the contact is impaired, insuring against a high resistance or broken contact with the resistance element. As a matter of fact, our thousands of tests have proved that this type of contactor affords a noiseless volume control even when the winding is fouled with dirt, dust, etc., sufficient to render any of the conventional types of volume controls

noisy and unusable. *Fatigue tests show that our No. 20 Series Controls can be depended upon for 1,000,000 complete rotating operations without trouble of any kind developing.*

Our No. 20 Series Controls are completely enclosed in dust-proof cases to exclude all foreign substances from the resistance element chamber. Extreme care is taken to keep these foreign substances from getting into the resistance chamber during manufacture.

The high resin-content bakelite strip used in Frost-Radio No. 20 Series is made especially for our own use. This, plus our lubricating system which entirely surrounds the strip and all insulations with a neutral oil film, positively insures against loose wires or changes in dimensions of the insulated parts. Shaft material is needle bar steel ground to plus or minus  $.0005''$ , rotating in a reamed brass journal. Our new construction entirely eliminates end thrust, a frequent cause of mechanical roughness in some rheostats. A. C. switches may be mounted on either single controls or tandem units at any desired angle from the soldering terminals. These switches occupy less than half the usual number of degrees of movement, giving an increased length of effective resistance element. Separation of driving arms in tandem units reduces capacitance to a negligible quantity, while our driving coupler used in these units provides universal joint action and thus eliminates binding and rough running.

*We invite engineers to send us specifications, upon receipt of which we will gladly send samples for experimental and test purposes.*

PRACTICAL experiment-ing with this new type of unit, illustrated in detail on the opposite page, began early in 1930 and tests have been carried on continuously for more than twelve months in order to thoroughly prove in the principles involved in its design and construction.



No. 20 Series  
Single Control



No. 20 Series Single  
Control with A. C. Switch



No. 20 Series  
Tandem Unit  
with A. C. Switch



No. 20 Series  
Tandem Unit

# FROST-RADIO



# Action!

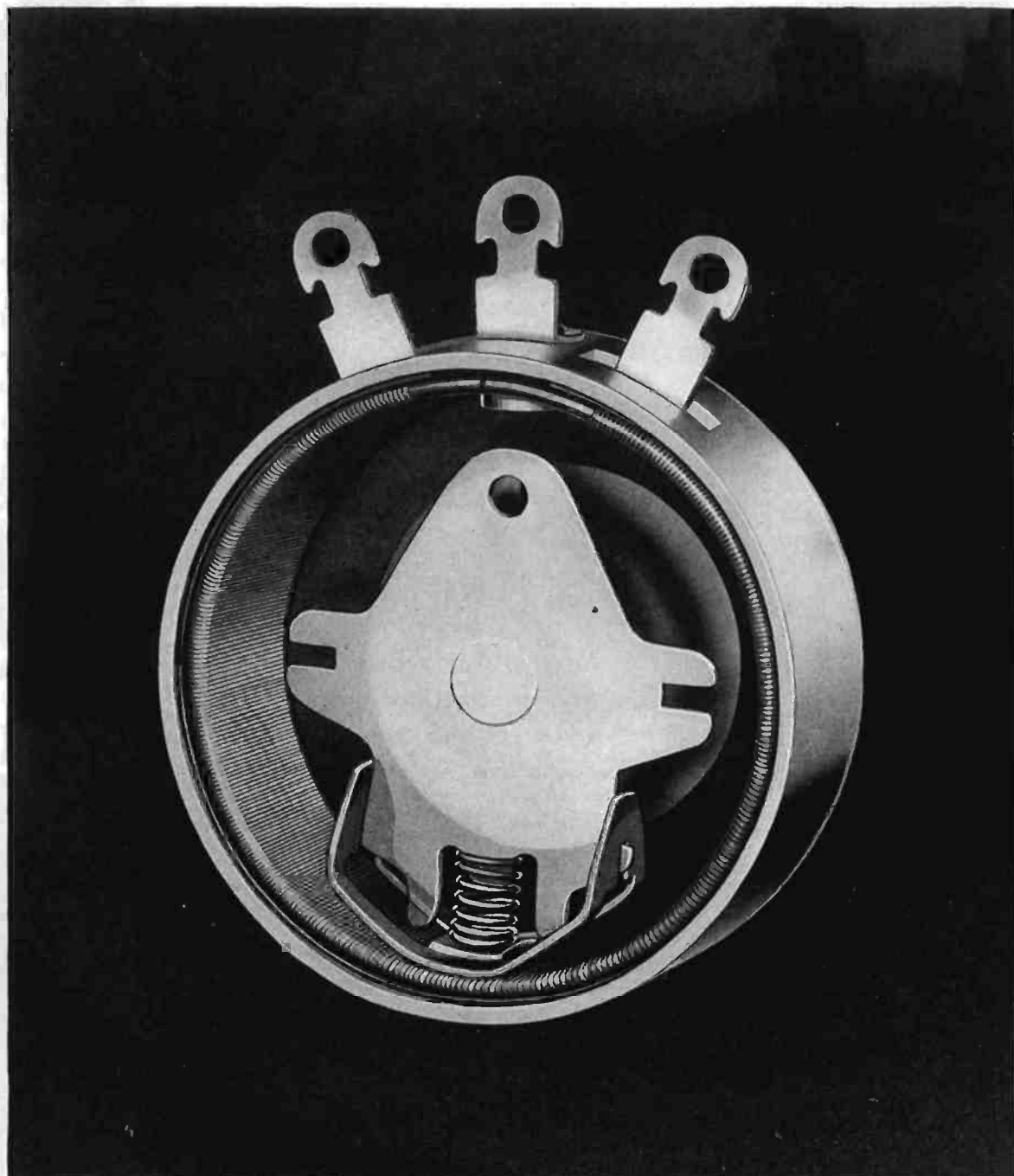

CHICAGO TELEPHONE SUPPLY CO.

HERBERT H. FROST, Inc.  
SALES DIVISION

General Offices ELKHART, INDIANA and Plant

# This Business of Tolerances

THE production of more than twenty million volume controls for radio reception has given us many interesting facts and has helped to dispel a number of obviously erroneous theories and contentions.

Even though it is possible to build a receiver that could split a kilocycle, it would be impractical for public use. The tolerances would be too small . . . too exacting.

Mass production of radio makes such precision engineering impractical . . . even laboratory models cannot aspire to such standards.

Given a standard radio of undeviating exactness, unaffected by temperature, humidity, and the stray atmospheric and mechanical inductances that are all about us, it would be possible to build a volume control definitely suited to that *one and only* receiver.

But to make this one control fit into a million sets is an obviously different matter. Yet CENTRALAB has been successfully meeting the requirements of set manufacturers whose control demands run into millions.

Our knowledge of the tolerances required is backed, as we have mentioned above, by this unparalleled performance.



**MAIL  
COUPON  
NOW**

CENTRAL RADIO LABORATORIES  
928 Keefe Ave., Milwaukee, Wis.  
Enclosed find 25c for which send at once  
your new VOLUME CONTROL GUIDE.  
Name.....  
Address.....  
City.....State.....  
R. Eng.

# Centralab

CENTRAL RADIO  LABORATORIES

928 Keefe Ave.

Milwaukee

# THE O. K. THAT CAME INSTANTLY

When the production department of a leading radio manufacturer recently made up a large requisition for coils, the engineering department unhesitatingly specified Inca coils.

The reason was perfectly simple . . . the engineers knew from experience that the electrical and physical characteristics of Inca coils can be relied upon.

Present day Inca quality takes its root in the same spirit of copper craft which brought undying fame to the prehistoric Inca of old Peru.

Today, Inca stands for continuous improvement . . . for absolute dependability. What better foundation on which to base the O. K. of modern Radio Engineering?

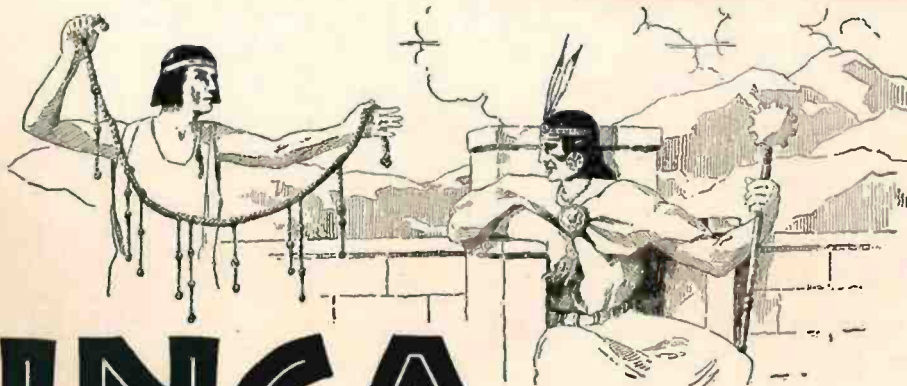
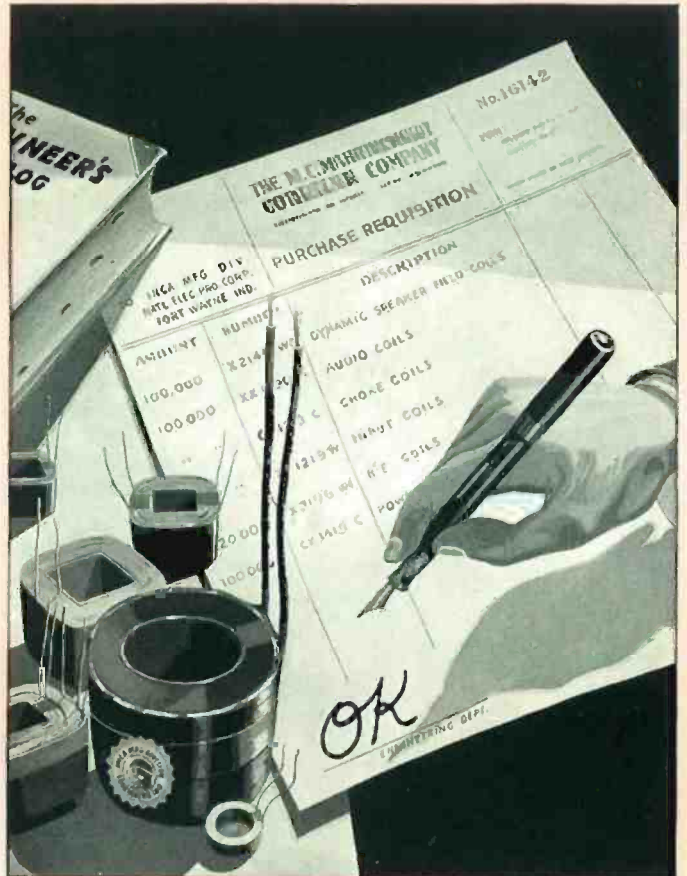

The Peruvian Oquipu is perhaps the oldest form of recording known to archaeologists and historians. The position of each knot, the color of each strand, had its particular significance to the Incas. The Oquipu was used largely as a system of bookkeeping in recording the amount or grain, or cloth, or the numbers of animals owned by an individual or a tribe.

## INCA MANUFACTURING DIVISION



Symbolic of the best in copper wire products.

Eastern Office: 233 Broadway, New York, N. Y.

Western Office: 1547 Venice Blvd., Los Angeles, Calif.

of NATIONAL ELECTRIC PRODUCTS CORPORATION  
FORT WAYNE, INDIANA



STEVENS HOTEL



**ANNOUNCING  
BUSINESS FOR YOU  
AT THE  
FIFTH ANNUAL**

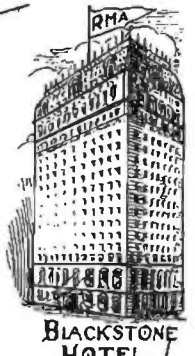

BLACKSTONE HOTEL

# **RMA Trade Show** **AND 7TH ANNUAL RMA CONVENTION** **CHICAGO** **JUNE 8 to 12th**



## **EVERYBODY WILL BE THERE**

Every branch of the radio industry will be at Chicago during the week of June 8th. This will be the largest gathering and biggest annual event of the industry.

Thirty thousand (30,000) square feet of radio exhibits in Grand Ball Room and Exhibition Hall of Stevens Hotel.

**ADMISSION TO THE TRADE ONLY. NO VACANT BOOTHS—ALL EXHIBITORS REQUIRED TO SHOW CURRENT MERCHANDISE.** The newest and latest receiving set models and accessories will be displayed and demonstrated at the show and in hotel demonstration rooms, for the trade to see what the manufacturers offer for the coming season.

25,000 radio manufacturers, jobbers and dealers expected to attend.

Reduced railroad rates—special trains.

Official hotels—Stevens Hotel (headquarters), Blackstone, Congress and Auditorium Hotels, all within short walking distance on Michigan Avenue.

### **INDUSTRIES AND EXHIBITIONS**

Radio industries, June 8-12—RMA, National Federation of Radio Associations and Radio Wholesalers Association.

Music Industry Convention and Show—June 15-17.

Institute of Radio Engineers Annual Convention—June 3-6.

Annual national "Furniture Mart" with 25,000 furniture buyers, jobbers, dealers and manufacturers—June 1-15.



CONGRESS HOTEL

Entertainment galore for visitors—Make a trip to Chicago for business and vacation combined.

Apply now direct to hotels for room reservations.

Invitation credentials for the trade show will be mailed to the trade about May 1st.



AUDITORIUM HOTEL

**RADIO MANUFACTURERS ASSOCIATION**

11-W. 42ND ST. N.Y. CITY

32 W. RANDOLPH ST. CHICAGO





## DUBILIER CONDENSER CORPORATION

4377 Bronx Boulevard,  
New York City

# Announcing

## DUBILIER ELECTROLYTIC CONDENSERS

• In meeting the demand of the radio industry for inexpensive capacity, Dubilier engineers have developed the Dubilier Hi-Mike Condenser—a refined semi-dry high-voltage electrolytic condenser with these outstanding characteristics:







1. Aluminum can  $4\frac{1}{2}$  by  $1\frac{3}{8}$  inches, interchangeable with other standard electrolytic units.
2. Available in upright and inverted types.
3. Standard capacity of 8 mfd., with highest percentage of effective capacity.
4. Working voltage conservatively rated at 400, peak of 430, or more than ample for — 80 type rectifier circuits.
5. Fully self-healing, reforming faster than any other electrolytic condenser.
6. Lower leakage at high voltages than any other electrolytic condenser.
7. Life expectancy in excess of requirements of usual radio assembly.
8. Compact, clean, non-spillable, efficient, inexpensive, self-healing, reliable.

Thus the Dubilier organization brings two years of research and engineering development on electrolytic condensers to a practical conclusion. The results are available to you in meeting your condenser requirements. May we present complete details and samples?

# YOU WOULDN'T TOLERATE A LEAKY ROOF



*How do your customers  
feel about leaky insulation?*

OF course the insulation in your product was supposedly good when it left your  plant. (So was your roof when it was put on.) But if it is unreliable, falls down under use, leaks — you lose customers. » » » That's the reason an increasing number of manufacturers are turning to Synthane  Laminated Bakelite. They know that it's reliable, that it stands up — that it makes  reliable products and in turn, satisfied customers. » » » In addition to high dielectric strength, Synthane has many other superior features, both electrical  and physical which we will gladly explain to you. It is made only of the finest materials  which in turn give you only the best results. » » » Your customers will not tolerate leaky insulation any more than you would tolerate a leaky roof. Be sure — use Synthane. Generous samples for testing  sent on request. Synthane Corporation, Oaks, Pennsylvania.

**SYNTHANE**  
Laminated Bakelite

NEW YORK · CHICAGO · PHILADELPHIA · DAYTON · LOS ANGELES · SAN FRANCISCO

E  
F

ers  
n?

ldly  
n it

raks  
ing

ted  
hat

ers.  
has

ical  
of

est  
on

on  
a.

O

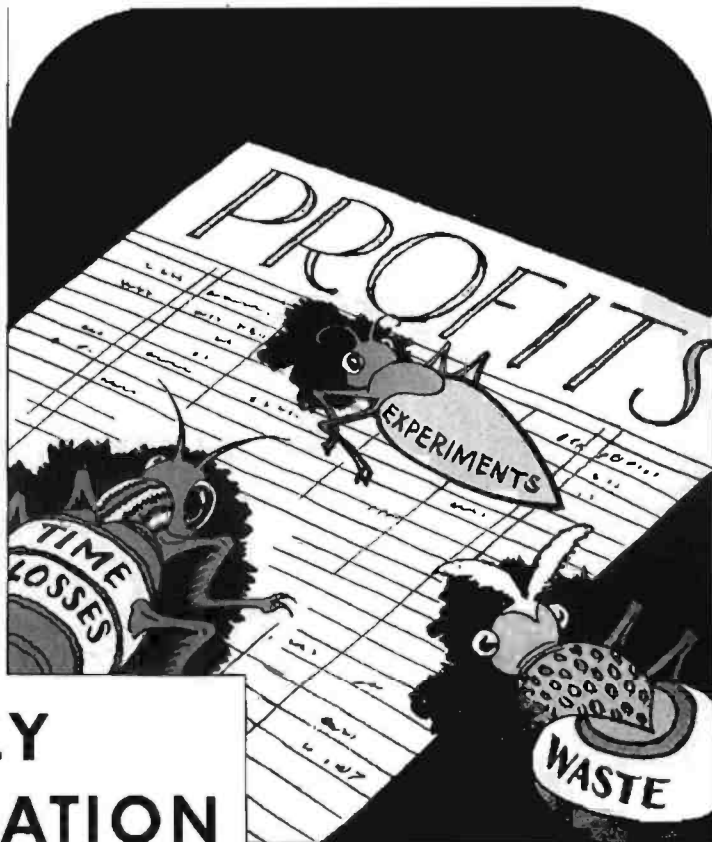
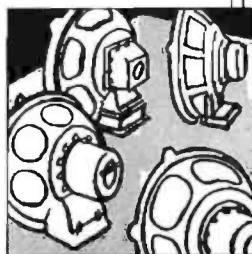

# Is COSTLY EXPERIMENTATION

## *eating up your profits?*

**P**RODUCT development is costly — so costly that many set manufacturers have concluded that to strive for "something different" in speakers is a needless duplication of effort involving wasted materials and high costs. It feeds upon your profits — profits that come hard in a price market.

This is an era of specialists. Rola dedicates its whole plant and facilities to the design and manufacture of one product: radio speakers. In a Rola speaker you obtain the experience of men whose whole background is a history of the talking unit, whose whole time is consecrated to the development of it, whose daily contact is with the peculiar problems of many manufacturers. Continuing costly experimen-

tation on speakers is to compete with these finely organized, efficient and reliable facilities. You cannot afford to do this.

In a Rola speaker you have a unit that has convincingly proved its economies and unequalled tone qualities. A number of outstanding radio manufacturers use Rola speakers. They secure "that something different" at less cost than they could produce a speaker unit themselves. They save the experimental expense!

Your profit margin can be widened by relying on specialists. Rola is equipped to handle your speaker without needless experimentation. A request will bring a representative or descriptive literature—whichever your letter indicates.

### ROLA SPEAKERS

*for better  
Radio Reception*

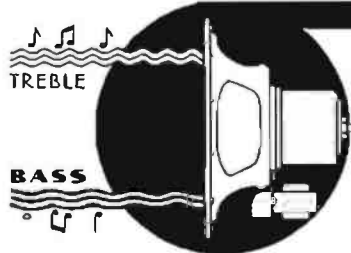

**THE ROLA COMPANY**  
2570 Superior Avenue  
Cleveland, Ohio

Manufacturers of Loud Speaker Units for Mantel, Automobile and Console Sets. Also high power Loud Speakers for Public Address Systems and Talking Pictures.

---

**Rich coil experience**

**Rich wire experience**

**Unite for your Benefit**

---

Under General Cable, the wire and cable making experience of many manufacturers is united to form a fund of wire knowledge that is unique. Every improved process or material known to any of the organizations affiliated in General Cable is used by all. To this fundamental advantage in the making of wire is added the combined experience of Dudlo, Rome and others in the production of coils.

Beginning with the copper bar, and ending with the final test, inspection and packing of the

finished coils, every step represents highly developed present-day technique. There it does not rest. Far leadership can not rest, and continue to be leadership. Therefore, in well-equipped laboratories every physical, chemical and electrical factor that applies to coils is subject to further scientific search for improvement or economy.

Coils purchased from General Cable carry with them the assurance that you have the best that science, skill and extensive manufacturing facilities can produce.

---

**GENERAL CABLE CORPORATION**

EXECUTIVE OFFICES: 420 LEXINGTON AVENUE, NEW YORK • OFFICES IN PRINCIPAL CITIES





# The ELKON Non-Aqueous Hi-Volt Condenser-

## OUTSTANDING CHARACTERISTICS

**1** High Working Voltage: 450 volts—withstands without injury transient peaks in excess of 575 volts.

**2** Absolutely Dry: A condenser from which all water is eliminated.

**3** Low Leakage: Normal rated leakage 0.1 mil per mfd. (After operating short period the leakage is 0.025 mils per mfd.)

**4** Impervious to Low Temperatures: Operates efficiently from minus 40° F to 150° F.

**5** Long Life: To reduce replacements and interrupted service periods to a minimum.

**6** Self Healing: Transient peaks in excess of 575 volts do not injure the Elkton condenser.

**7** Compactness: Smallest cubical volume per microfarad of any condenser on the market.

**8** Maximum Filtering: Due to low power factor, the Elkton condenser has the greatest filtering action of any electrolytic condenser on the market.

**9** Stability in Operation: To guard against mechanical and electrical variation that would affect action of the circuit.

**10** Low Cost Per Microfarad Per Voltage Rating: A large safety factor in volt rating for the same cost as lower voltage condensers.

# 450

Working Volts  
Any Combination  
of Capacities. Wide  
Variety of Can Sizes.

Greatest Filtering  
Capacity of Any Electro-  
lytic Condenser—

Samples built to your specifications will be sent to all recognized manufacturers.

Send for booklet giving complete technical data and general description.

**ELKON DIVISION**  
P. R. MALLORY & CO., Incorporated  
Indianapolis, Indiana



SMALL  
Typical can size  
16 Mfd. Condenser,  
4 1/4" x 2" x 1 1/4"

Booklet with complete  
data upon request.



### Standard Can Sizes and Their Microfarad Capacities

Vertical and Horizontal Cans			Vertical and Horizontal Cans			ROUND CANS		
MPD Capacity of Sections	Total Capacity MFDs	Can Size	MPD Capacity of Sections	Total Capacity MFDs	Can Size	MPD Capacity of Sections	Total Capacity MFDs	Can Size
1	1	2 3/4 x 1 x 1/2	6	6	4 1/4 x 1 1/2 x 3/4	4-8-12	24	4 1/4 x 2 1/2 x 1 3/4
2	2	2 3/4 x 1 3/8 x 3/4	8	8	4 1/4 x 2 x 3/4			
2-2	4	2 3/4 x 1 3/8 x 1 1/2	8-8-8	16	4 1/4 x 2 x 1 1/2			
2-2-2	6	2 3/4 x 1 3/8 x 2	8-8-8-8	24	4 1/4 x 2 1/4 x 1 3/4			
2-2-2-2	8	2 3/4 x 1 3/8 x 2 3/4		32	4 1/4 x 3 x 2	4	4	1 3/8 dia x 2 3/4
4	4	4 1/4 x 1 x 1	2-4-8	14	4 1/4 x 2 x 1 1/2	8	8	1 3/8 dia x 4 1/4
4-4	8	4 1/4 x 2 x 1	2-8-8	18	4 1/4 x 2 x 1 3/4	8-8	16	2 1/2 dia x 4 1/4
4-4-4	12	4 1/4 x 1 3/4 x 1 3/4	2-8-16	26	4 1/4 x 2 1/4 x 1 3/4	8-8-8	24	3 dia x 4 1/4
4-4-4-4	16	4 1/4 x 2 1/2 x 1 3/4	20	20	4 1/4 x 2 x 1 1/4	8-8-8-8	32	3 dia x 4 1/4
5	5	4 1/4 x 1 1/2 x 3/4	30	30	4 1/4 x 2 x 2			

— A CONDENSER FOR ALL POWER PACK ASSEMBLIES —

# A new policy

---

THE Scovill Manufacturing Co. announces a line of high-grade variable condensers in standard capacities, for prompt delivery in moderate quantities, moderately priced. \* \* \* \*

## SCOVILL MANUFACTURING CO. WATERBURY CONNECTICUT

New York                      Philadelphia                      Boston                      Providence  
Chicago                      Detroit                      Akron                      Cincinnati  
Atlanta                      San Francisco                      Los Angeles  
In Europe: The Hague, Holland

# Scovill



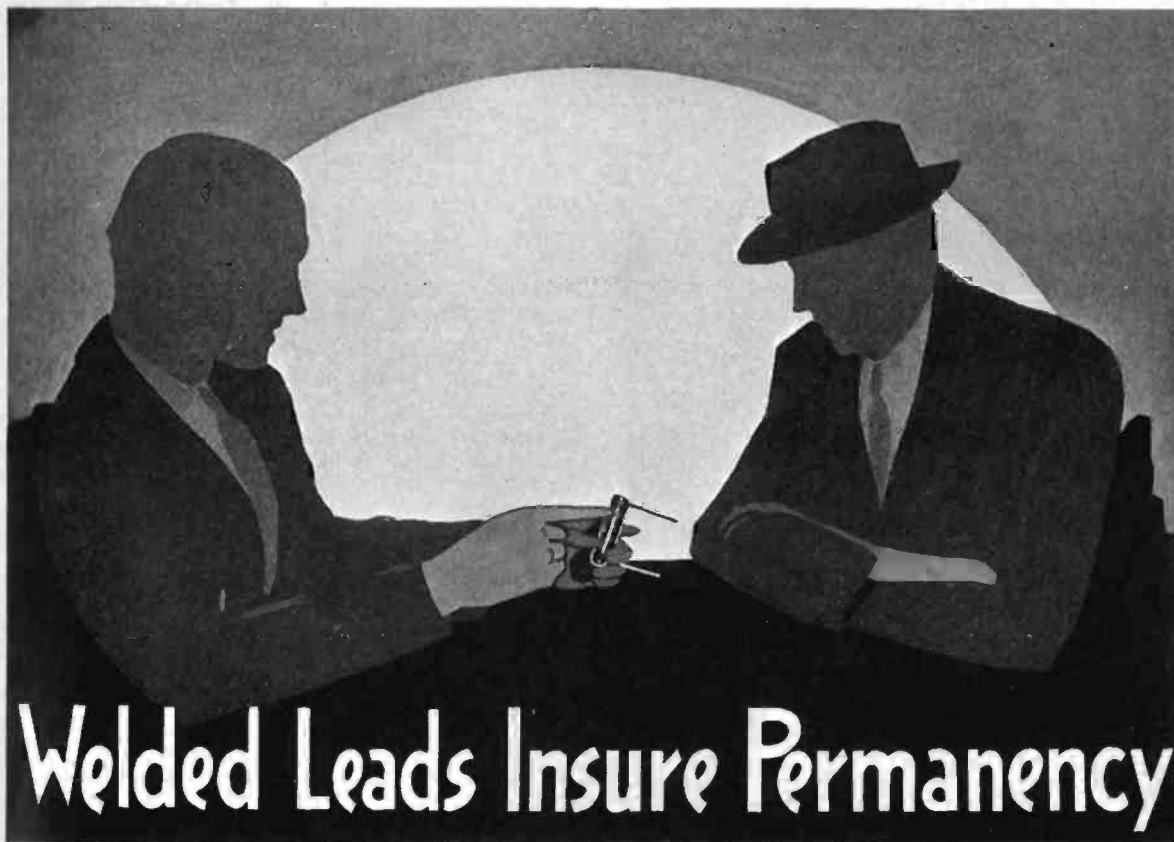

# Welded Leads Insure Permanency

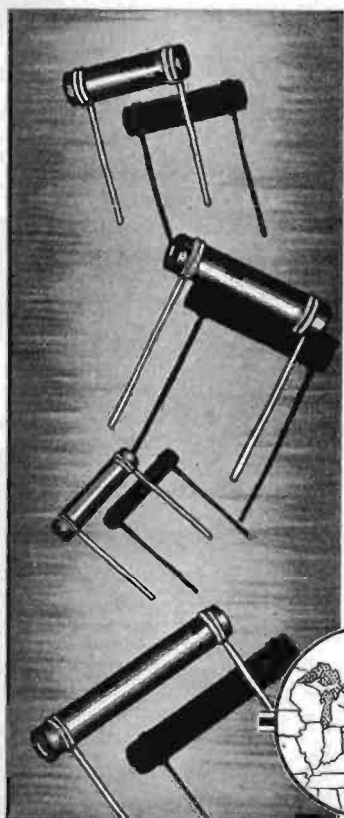

Loose connections and their consequences are avoided by ERIE RESISTOR construction

The leads on ERIE RESISTORS are welded to the resistor and form a permanent connection which is not affected by heat and cold. This feature prevents loose connections and their consequences.

Users of resistors will find that ERIE RESISTORS deliver unusual performance by reason of the skill and care used in their manufacture.

Inspection methods insure uniformity of resistance values—ERIE RESISTORS are noiseless and will pass every test of your engineers.

May we send you samples and prices?

## ERIE RESISTORS

Erie Resistor Corporation, Erie, Pa.  
In the Center of the Radio Industry

# Impressions and Expression

By AUSTIN C. LESCARBOURA

## ELECTRICAL TRANSCRIPTIONS

WITH our leading networks now interested in the possibilities of electrical transcriptions or recorded programs, it begins to look as though we must take them—the transcriptions, of course, not the networks—seriously.

Technically, the electrical transcription is almost the equal of the direct pickup feature, and usually as good, or even better, than the feature transmitted over wire lines to associated stations. Even the highly trained ear has difficulty in distinguishing between the recorded program and the original program feature. However, so far as the public is concerned, the idea of a recorded program appears to be most displeasing, so that the electrical transcription sponsors have quite a job on their hands by way of gaining public acceptance. Little wonder that they are exerting pressure on the Federal Radio Commission to have the announcement, "This is an electrical transcription," dropped from the broadcasting pattern.

As we see the picture, electrical transcriptions have a definite place in the broadcasting setup, but only for the time being. We expect them to be replaced in the near future by sound-on-film records, particularly since many broadcasting stations are certain to have radio television supplements within the next two years. And when that happens, the stations will be provided with modified film projectors or pickups for handling combined pictures and sounds for the complete recorded sponsored program. Admitting that many stations are now equipped with 33 $\frac{1}{3}$  r.p.m. turntables for electrical transcriptions, we still believe that the big records are but temporary improvisations.

## THOSE MEXICAN STATIONS

UNTIL recently we Americans have enjoyed comparative isolation in our radio affairs quite as well as in other directions. We have had little sympathy with the interference and embarrassing exchange of propaganda indulged in by the closely packed peoples of Europe. Thousands of miles separating us from Europe, together with friendly agreements with our Canadian friends, and the neighbors to the south, have allowed us a virtually American ether. But things have changed of late. The sudden activity of our Mexican friends has introduced a degree of interference which promises to prove troublesome.

Mexico today has a dozen or more broadcasting stations. Several are of 5 and 10 kilowatts. There is talk of 50 kilowatt stations. Some of our disgruntled broadcasters, unable to secure the power which they desire, have threatened to cross the Rio Grande and become Mexican. Many of our stations are experiencing interference from these Mexican broadcasters, whose signals cover every part of our country at present.

Before this matter gets too far, some constructive program is essential. Just as we have dealt with our Canadian neighbors in a friendly manner, so we must deal with our Mexican neighbors. Also, we are going to find it necessary to assign a few exclusive frequencies to those Mexican stations within the present broadcast band, for otherwise we are going to have an interference mess. Furthermore, we must hasten with our frequency synchronization technique, for otherwise we are going to have entirely too much interference among the limited wavelengths.

And don't forget, there are many other countries in I America which may yet want a place in the Amer ether. Hence a big engineering problem, as well as a d matic one, faces us now.

## BROADCASTING GOES WORLD-WIDE

QUITE aside from the ject matter, the broadcast from Station HVJ, Vatican Rome, on February 12th, was a revelation to the techn as well as lay radio audience. In signal strength, abs of fading and good modulation, this station, designed installed under the supervision of Senatore Gugli Marconi himself, leaves little to be desired. With a po rating of 10,000 watts, it is apparently capable of reach most parts of the world with sufficient signal strength satisfactory direct reception by short-wave fans, and rebroadcasting purposes.

One thing is certain: We are on the eve of internati broadcasting as a regular thing. Short-wave receivers going to become popular. Many of our broadcast liste are going to insist on receiving their own short-wave grams at will rather than depend on the rebroadcast activities of the networks. And very soon the various nat of the world are going to find it impossible to feed th people the usual censored news of doings abroad, since th people will pick up their own uncensored news from abr

This international broadcasting matter is a serious l to diplomacy. Peoples are going to get to know one ano better than ever before. Better education than ever be will be necessary to train people to withstand the di propagaula of Communism and Facism coming via ra The world forum is at hand.

## TELEVISION CONSCIOUS

A MARKED revival in r television activities during the past month. Showman is at last entering into the development of this new radio From Chicago comes word of real television plays, wit combination of direct pickup scanners permitting of cl ups, half lengths and long shots, fading from one to other in rapid succession, thereby providing some of flexibility which has served to make the motion pic presentation so popular. In the New York metropol area, one station is now on the air with real progr including singers, soloists, musical ensembles, lectur public men, and so on, who may be seen as well as he From Boston comes word of a brisk sale of television eq ment through a chain store, so that the local televis programs may be enjoyed.

Although it has been stated and reiterated time and ag that television is two or three years away, so far as ev day use is concerned, we reaffirm our belief that it about to break. We have good reasons to believe that leaders of our industry, in patents, production facilities v broadcasting activities, will join the television workers v practical television by this coming fall. Before the enc the year, we shall have radio television programs f coast to coast, television equipment on sale for home use least 50,000 lookers-in as a starter, and a revived ra industry based on television.

MARCH, 1931



# It's Easy To Identify 1931 Tubes

## Look for Practical Quick Heaters

A radio set should start up in a few seconds. But are you willing to pay the usual price of short tube life and uncertain performance? De Forest engineers have eliminated the gamble by unique design:

1. Full-length cathode sleeve, minimizing hum and crackle. One-thirtieth usual hum level.
2. Notched insulator (patent applied for) reducing bulk yet retaining twin-hole insulator advantages.
3. Special hair-pin filament for neutralized A. C. field. Lower operating temperature than coiled type with freedom from brittleness.
4. Filament supported at twelve points. Cannot vibrate to cause microphonic noises. Cannot short circuit.

These and many other advanced features found in every type of fresh De Forest Audion, insure the 1931 performance of the 1931 radio sets.

*This is the third of a series of debunking messages dealing with 1931 radio tube features. Would you like the entire story at this time?*

DE FOREST RADIO CO., PASSAIC, N. J.

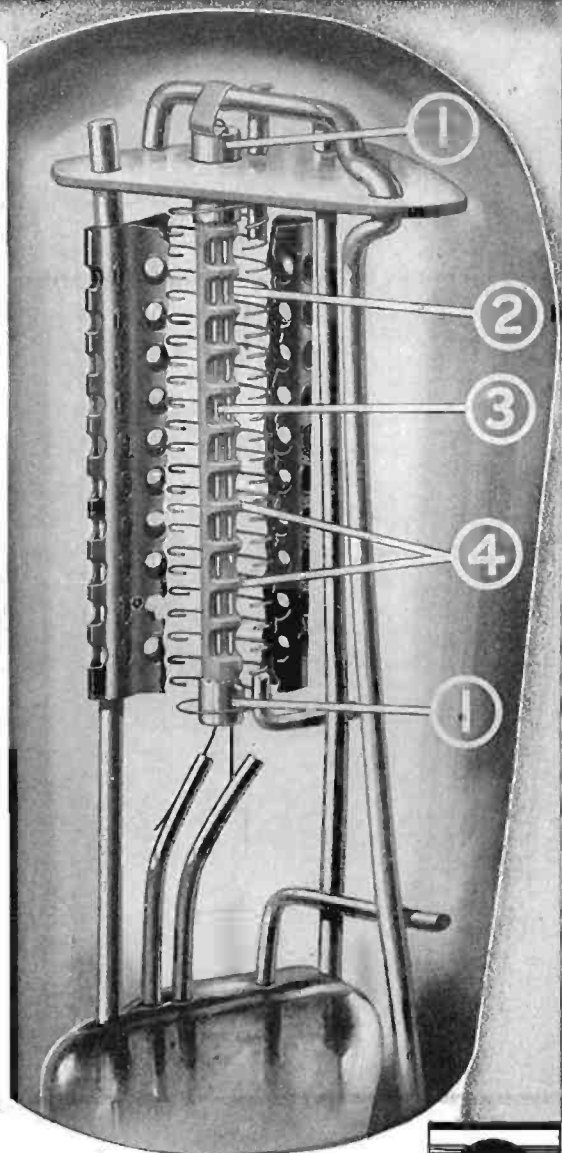

*de Forest*  
**AUDIONS**  
**RADIO TUBES**



After all, there's no substitute for 25 years' experience

# G-E MINIATURE INSTRUMENTS

You will find a high-quality, miniature instrument of any rating in General Electric's new line. *It's complete!*

Ammeters range from 1 to 3000 amperes . . . milliammeters, from 0.5 to 750 milliamperes . . . microammeters, from 75 to 750 microamperes . . . voltmeters, from 1 to 3000 volts . . . and millivoltmeters from 10 to 750 millivolts. Thermal instruments in all ratings. Voltmeters with resistances as high as 4000 ohms per volt.

They are available for alternating and direct current . . . in two sizes, 2½ and 3½ inches, for panel mounting. There's a neat, little portable combination, too, a high-resistance voltmeter for alternating and direct current.

Write to the nearest G-E sales office or to General Electric Company, Schenectady, N. Y. Ask for a copy of GEA-1239, which gives complete data for selecting and ordering.

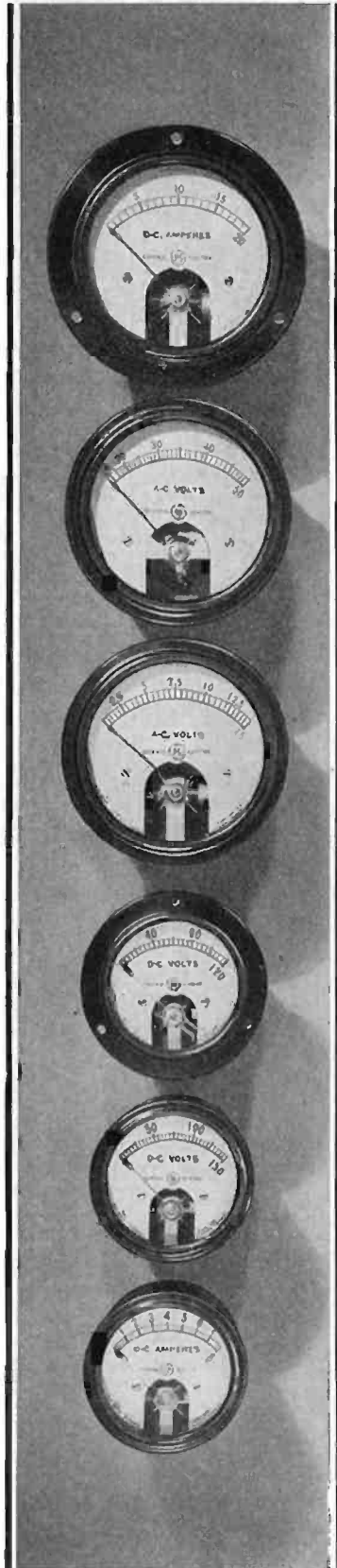

## GENERAL ELECTRIC

Join us in the General Electric program, broadcast every Saturday evening on a nation-wide N.B.C. netw

610

# RADIO ENGINEERING

Production, Administration, Engineering, Servicing

MARCH, 1931

## Bias Detector Overload

BY J. R. NELSON

It is well known that detector overloading occurs when the input voltage exceeds a certain value. The overloading manifests itself on a listening test by the power output level either remaining constant or falling off as the detector input voltage is increased and also by a change of quality. The harmonic content increases rapidly as the overloading point is reached and at some point the fundamental is lost altogether as will be shown later. Detector overloading acts in the same manner when power output measurements are being taken. The shape of the power output curves for various percentages of modulation are different and the reasons for this difference will be apparent later.

### Effect of Overloading, Important

Very little has been done on the theory of detector overloading. This neglect has not been due to its lack of importance as the overload characteristics are one of the important features of a receiver as is well known by anyone operating a receiver having poor overload characteristics. Like all other conditions detector overloading characteristics may be improved by a knowl-

edge of the factors causing this overloading. The reasons for detector overloading will be found from experimentally determined tube curves. The theory derived will be applied by calculating some power curves which will be compared with the measured curves.

The case of most practical interest today is that of the so-called linear detector which utilizes input voltage of the order of volts instead of tenths or hundredths of a volt as was the case with the previous small signal detectors. The above case only will be considered here. Small signal theory becomes very difficult to apply when the input voltage is of the order of volts so that the detector theory will be studied by means of certain easily measured tube characteristics.

The method used here consists of first finding experimentally the relation between the power output and the audio-frequency voltage introduced in an external detector plate circuit of the receiver under consideration. The rectification diagram or the relation between the detector input voltage and the rectified output are found next. The audio-frequency voltage in the external detector plate circuit for various carrier voltages and percentages of modulation may be computed from these rectification diagrams. The power output for the given conditions may then be found from the relation between the external detector plate audio-frequency voltage and the power output relations of the receiver.

Fig. 1 shows the schematic diagram of the circuit connections used to determine the relation between the power output and the audio-frequency voltage. This method may be applied to any particular audio amplifier. The detector tube is removed and the input voltage is applied directly across the resistance,  $R$ . It is to be noted, except as to frequency discrimination, the value of  $R$  makes no difference as the power output is found for the actual voltage in the detector plate which value of voltage is found from the rectification diagram. In case a transformer is used a resistance must be used in series with the primary to simulate the tube resistance. A direct current should also be sent through the primary. In this case the relation will be between the voltage introduced internally in the detector and

the power output. If the frequency used is around 400 cycles, it may be assumed that this voltage is the same as the external voltage. An exact analysis is somewhat complicated and will be beyond the scope of this article, but approximate results may be obtained as explained by assuming that the voltage introduced is the same as the external voltage.

Fig. 2 shows the results obtained from an amplifier using resistance coupling between the detector and first audio tube which tube is transformer coupled to the push-pull stage by means of a transformer having a 3 to 1 overall ratio. The output uses two 245 tubes in push-pull. The output is approximately proportional to the square of the input voltage up to about four watts after which it decreases slowly with increasing input voltage. The output reaches a maximum of about 7.0 watts but normally only 3 to 4 watts could be used because of distortion.

### Characteristics of 227 Tube

Fig. 3 shows the  $I_p$ - $E_b$  characteristic curves of an Eveready Raytheon 227 tube with various input voltages impressed on the grid of the tube. An 8,000 ohm resistor was used in series with the cathode to obtain bias from the tube, the grid being connected to the other side of the resistor. The resistor was by-passed with a 4 mf. condenser for the input frequency; in this case 60 cycles. The current is plotted versus the voltage supplied to the tube and resistor in series. The curves for small input signal voltages are about as would be expected. The curves for higher input voltage, however, rise very steeply and do not pass through the origin. The reason for this is that in addition to the d-c. plate supply there is also a d-c. drop across the cathode resistor due to grid current.

If there is no a-c. voltage on the grid there will be no bias on the tube until plate current starts. If an a-c signal is impressed on the grid of the tube,

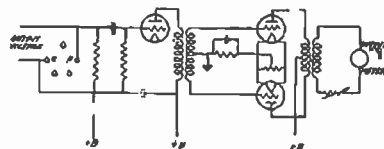

Fig. 1. Circuit for test.

▲

The Overload Characteristics of Radio Receivers are of Importance in Receiver Design.

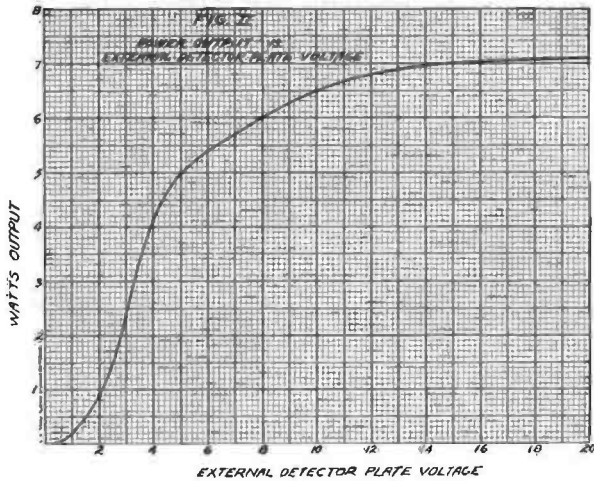

Fig. 2. Results obtained from an amplifier using resistance coupling between detector and the first audio tube.

current will flow during the positive cycle provided there is no bias. This current will cause the grid to become negative. The time constant of the bypass condenser and resistor is of such value that the condenser will hold a considerable portion of its charge over the whole cycle. The grid thus has a negative bias due to its own current. The drop across the cathode resistor is also applied between the plate and cathode which makes the plate negative with respect to the cathode thus opposing the applied B voltage. Consequently, no current can be drawn by the plate even when the grid is positive until the applied B voltage is greater than the drop across the bias resistor. As soon as the plate becomes positive it will draw a large current during the positive excursions of the grid which current will increase rapidly with increased B potential. The total current that is the sum of the plate and grid currents remains practically constant at least from .1 to 1.5 ma. as the drop across the bias resistor remains constant within this range.

A 140,000 ohm load line is shown

drawn in from 165 volts which condition was used in a receiver. The rectified voltage curve is shown plotted for

Fig. 5. Audio-frequency voltage.

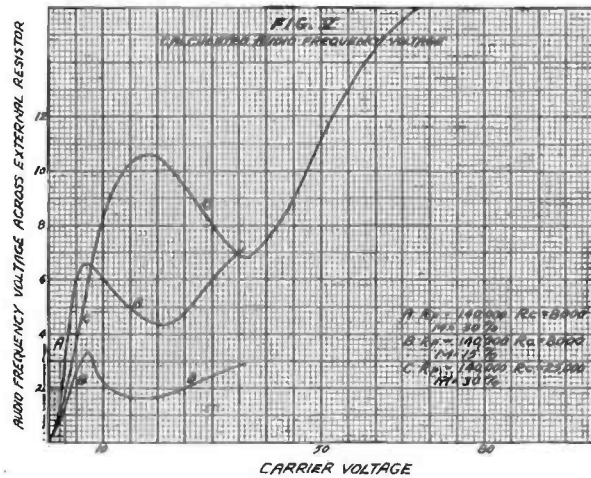

this condition in Fig. 4 A. The rectified voltage curve is obtained by finding the rectified, or change of d-c voltage

Operating Voltage

The location of the operating voltage for any given carrier may be found by the intersection of the  $I_b$ - $E_b$  curve for that carrier voltage with the load line curve. If a carrier voltage is modulated 100 per cent its peak value will vary between the projections of the intersections of the  $I_b$ - $E_b$  curves for  $2E$  and  $0$  with the load line. This will be the total change which is two times the value of a sine wave. Consequently, the r.m.s. value of output is the voltage between the two projections or in the case of the rectification curve the value for  $2E$  divided  $2\sqrt{2}$ . The output for any other modulation is found in the same manner as for example, the r.m.s. value of output voltage for a carrier modulated 50 per cent is the difference  $3/2 E$  and  $1/2 E$  on the rectification curve divided by  $2\sqrt{2}$ . An example will make the procedure clear. Assume a 6 volt carrier modulated 30 per cent.

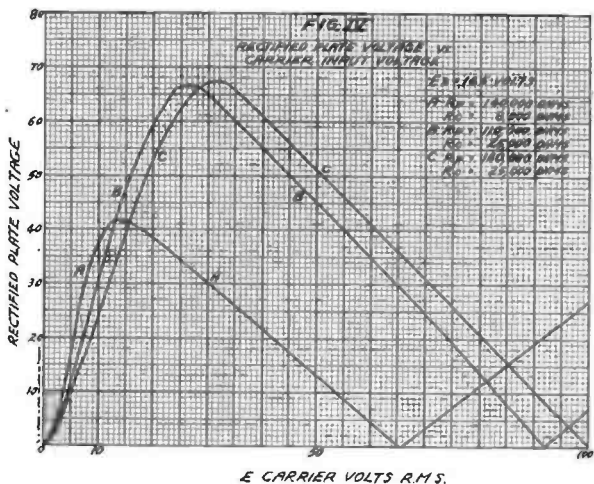

Fig. 4. Rectified plate voltage in relation to input voltage.

late resistancy may be by carrier modulation is to be increases; begins to voltage is volts. In t of 65.5 curve to true conegative. here the t will be frequency imagine continuation 5.5 volts ty. The ading at ation are rectifica-

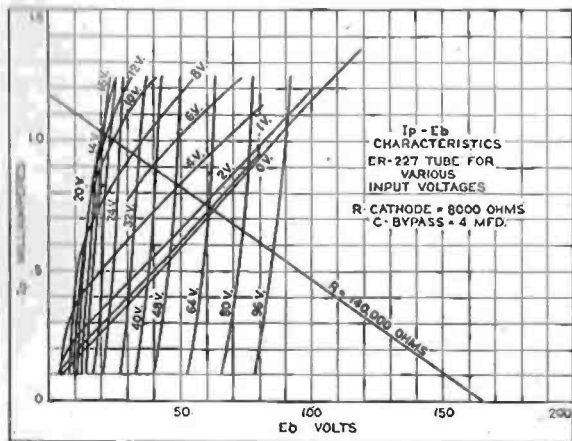

Fig. 3. Characteristics of 227 tube.

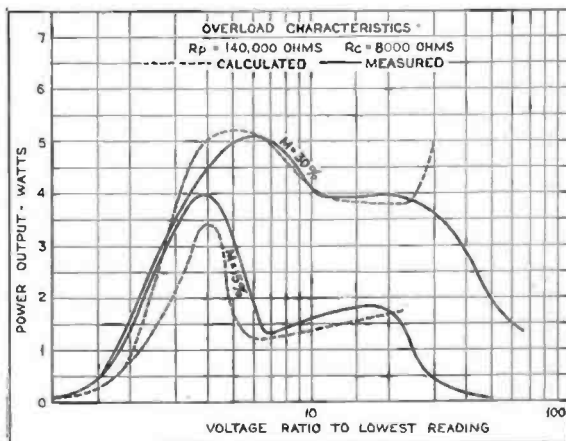

Fig. 6. Overload characteristic.

If the modulation is 33.3 per cent voltage will vary between the values for 4 and 8 volts which is 20.2 volts. The r.m.s. value will be  $20/2\sqrt{2}$  or 7.1 volts. The value for 30 per cent modulation will be  $30/33.3 \times 7.1$  or 6.46 volts. Similarly, the audio-frequency voltage may be calculated for other carrier voltages. Fig. 5 A shows the audio-frequency voltage plotted against voltage for 30 per cent modulation. It is to be noted that when the carrier voltage is 14 volts the rectified output falls off on either side so that the fundamental would be lost and the output would consist entirely of distortional components. The output at this point decreases with a decrease of modulation and in the limit would give no output because the curve changes in direction of curvature. The audio-frequency voltage in this range cannot be conveniently calculated so that it has been filled in to fit the shape of the curve.

The A-F. Voltage

The audio-frequency voltage for 15 per cent modulation was calculated in the same manner and is shown plotted

in Fig. 5 B. It is to be noted 15 per cent modulation overloads at a slightly larger value of carrier voltage than does the 30 per cent curve but the points are close enough together to take the point of detector overloading voltage as that given by a small percentage of modulation.

The power output may be calculated from the audio-frequency output voltage curves of Fig. 5 and power output curve of Fig. 6. In the measurements .08 watt was the smallest unit of power measured so that the detector plate audio-frequency required for this power output, .66 volt for 30 per cent modulation, was arbitrarily taken as the unit voltage in plotting both the calculated and measured power output curves. From Fig. 5 we find that 1.3 volts carrier gives .66 volt for 30 per cent modulation. This is plotted as one in the dashed calculated curve. (Fig. 6.) The audio-frequency voltage given by  $2 \times 1.3$  volts input is then found and the power output corresponding to this voltage is found from Fig. 2. This value is then plotted for a ratio of two units in Fig. 6. Similarly the other

readings for ratios of 3, 4, 5, etc. are found with these curves and the results are plotted in Fig. 6 for 30 per cent modulation. The calculated curve for 15 per cent was found in exactly the same manner, the voltage giving .08 watt, being 1.8 volts for 15 per cent modulation. This curve is shown plotted in Fig. 6 by the dashed curve marked 15 per cent.

The power output using exactly the same conditions was then measured for both 30 and 15 per cent modulation. The carrier voltage giving .08 watt was taken as unity. The power output for twice this voltage was then plotted as that given by the ratio of two, etc. In other words, both the measured and calculated are plotted in ratios so that shapes should be alike and the curves can be compared directly which is the feature desired here. The measured results are shown plotted by full lines of Fig. 6. The agreement is good until the ratio of 20 is reached after which the measured begins to decrease and the calculated begins to increase. The decrease in the measured curve is due to either the detector or amplifier over-

voltage found by curve for load line modulated will vary interior 2 E will be nes the uly, the voltage in the e value put for in the e r.m.s. carrier ference fication xample Assume r cent.

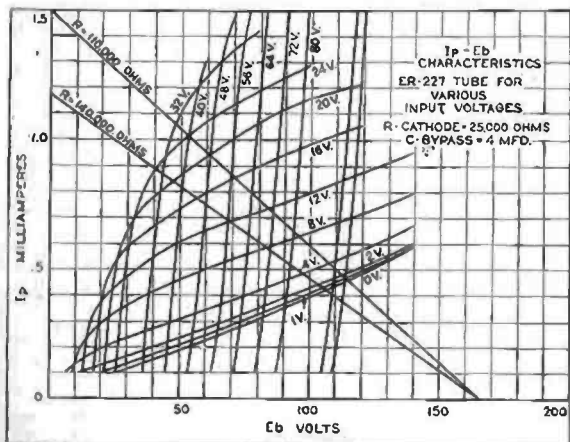

Fig. 7. Ip-Eb characteristics when 25,000-ohm cathode resistor used.

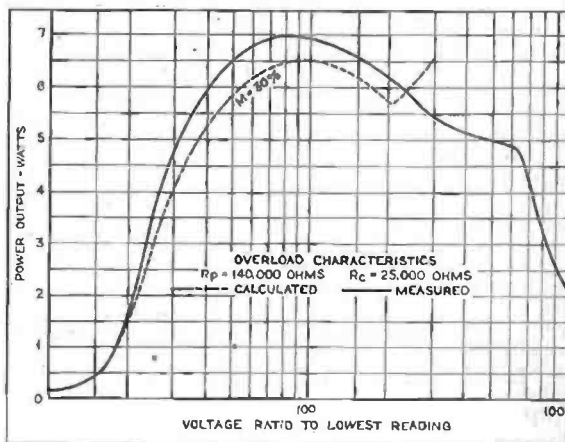

Fig. 8. Dotted lines; power output curve. Solid line; measured curve.



loading so badly that the waveform is flattened out. The agreement is, however, good enough to confirm the theory advanced.

The overload characteristics are not very good. The detector overloads even at 30 per cent modulation before it delivers enough voltage to overload the power tube or to flatten out the power output curve. It delivers more than enough voltage to give the rated value of 3.2 watts but the detector should overload the power stage before it overloads. The volume for a low value of percentage of modulation would reach a sharp peak and fall off rapidly, which is very noticeable in operation.

Conditions may be improved by using a larger cathode resistor. Fig. 7 shows the  $I_p$ - $E_b$  characteristic curves when a 25,000 ohm cathode resistor is used in place of the 8,000 ohm resistor, the supply voltage remaining the same. The rectified voltage curves for a 110,000 and 140,000 ohm resistor are

shown plotted in Fig. 4 B and C. The level is considerably higher than for the 8,000 ohm resistor.

The audio-frequency voltage for 30 per cent modulation using a 140,000 ohm resistor is shown plotted in Fig. 5-C. There is considerably more audio output voltage. The calculated power output curve is shown plotted in Fig. 8 by the dotted lines and the measured curve is shown plotted by the full lines. The agreement is fairly close, although the measured is somewhat higher. It is seen that these curves are flatter than the curves of Fig. 6, and that the detector delivers enough voltage to overload the power stage. The overloading would not cause such a sudden dropping off in volume for this condition as it would when an 8,000 ohm resistor were used.

The remedy for the output falling off sharply is quite easily found from the results. Refer to Fig. 2 and it is evident that the output increases slowly

after the external detector plate voltage reaches 10 volts. If the audio-frequency voltage is greater than 10 volts, the power varies little with reasonable changes in detector output voltage. The higher the detector output voltage the flatter the output curve will be so that the dropping off of power with an increase of radio-frequency voltage will be less noticeable. Of course, at the same time the quality will be improved by increasing the detector output voltage.

In practice it would not be necessary to repeat all the above steps in investigating circuit constants for a detector. Several rectification curves for various combinations of plate and cathode resistors would give enough information to choose the circuit constants giving the best overload conditions for a given B supply voltage. There is some loss in sensitivity in choosing a high value of bias resistor but the better overload characteristics more than offset this decrease of sensitivity.

## New Combination Radio Equipment for Yachts and Cruisers

**A** TRIAD marine radio, combining a broadcast receiver, position finder and compass in one apparatus, was recently developed in secret by the Pioneer Instrument Company, a division of the Bendix Aviation Corporation, and was shown for the first time at the twenty-sixth annual motor boat show at Grand Central Palace in New York City, January 16-24.

Tesis on each part and of the entire apparatus took place for days before the show, and it was not until the opening day that the radio was announced and its operation explained. The apparatus includes a loop antenna, antenna control wheel, receiver and speaker, and is mounted on a cruiser bridge in the Pioneer exhibit, where with the recently perfected straightway compass, it is attracting considerable attention. The Pioneer Company developed the famous earth-inductor compass, used by Colonel Charles A. Lindbergh on his transatlantic flight.

The new triad radio, in addition to program broadcasting, will receive all

signals to 1,200 meters. This includes all marine and commercial communications as well as SOS signals, storm warnings, half-hourly weather reports, light house beacons and radio compass signals.

When used as a position finder, the radio gives the yachtsman all the advantages of the facilities offered by the government to assist large boats to ascertain their position by radio. In the case of the triad, however, many other transmitting stations can be used, as any radio broadcasting station is a possible source of obtaining the position of the boat.

The method of determining position by radio is very simple. By setting the selector dial and rotating the loop antenna, any transmitting station the location of which is known is tuned in. When the signal or program of this station is received with minimum intensity, its position in relation to the boat is determined by noting the compass reading. Another station at least 30 degrees removed from the first is then tuned in and another compass reading is taken. By plotting on a chart the position lines obtained from these stations, the position of the boat is accurately determined.

### Visual Indicator Employed

Because of the inability of the human ear to determine with any great de-

gree of accuracy the point of absolute minimum volume of sound, the triad is equipped with means of determining this visually. This consists of an accurate electric meter which will show within a degree the point of minimum reception which is used in determining position. This visual indicator will pick up and indicate radio signals too indistinct to be audible.

The antenna loop, set like a huge doughnut on the roof of the cruiser bridge, is placed in the proper relation to the radio compass station and the boat is steered to keep the indication of the visual meter at a minimum reading. By maintaining this heading, the boat will be safely and accurately guided to its objective. Should a radio broadcasting station be sufficiently close to the line of the desired course, its transmitting wave may be used to steer by in the same manner as a radio compass transmitter.

It is essential that a compass, such as the straightway, be used if great accuracy of position finding is desired. Accurate compensation of the compass is very necessary.

There are many radio compass stations established throughout the navigable waters bordering the United States. Entrances to all important harbors are equipped with radio compass stations and also many light-houses and light-ships are also so equipped. Once the position of a boat has been determined, it is possible to use the instrument as a radio compass and make use of these facilities.

▲  
Secretly Developed Apparatus Combines Broadcast Receiver, Position Finder and Compass.

# Design Tests for Amplifiers and Complete Radio Receivers \*

By SYLVAN HARRIS

THE system of transmission units is rapidly finding an almost universal application in expressing the results of measurements or tests made upon radio apparatus such as amplifiers or complete receivers. However, the application of this system by engineers is often quite inaccurate, and in many cases, totally incorrect. The indiscriminate use of the system quite often leads to serious misconceptions concerning the quality of transmission of pieces of apparatus, amplifiers, or sections of lines.

For these reasons, among others, it is felt that a brief discussion of this system, with special regard to its application to radio receiver measurements, will be in order. The system of transmission units has been used for quite a few years in the telephone industry, and was devised for the purpose of expressing the grade of transmission of sections of lines or of pieces of apparatus inserted in the lines, so that by performing a simple arithmetical addition the grade of transmission of the whole line may be quickly obtained.

Thus, in a certain transmission line, consisting of several sections, A, B, C, D, the current, voltage or power at the terminus of each section is attenuated from section to section. By knowing,

\* Received by the Editor November 10, 1930.

**An Engineering Discussion of the Application of the System of Transmission Units to Various Circuit Measurements**

either through measurement or calculation, the attenuation of each section, the total attenuation of the line is equal to the product of the attenuation factors of the several sections. Or, if the separate attenuations are expressed logarithmically, the total attenuation to the sum of the separate values.

This part of the problem, at least in its general aspects, is quite readily understood. But there next arises the question as to the performance of a given section of a line when it is removed from the original line and inserted in another line. To put this in language which is more familiar to the radio engineer, let it be supposed that the "gain" of a certain amplifier when joined to a certain loudspeaker has a certain value. Will it have the same value when it is connected to another loudspeaker of different characteristics?

It is obvious that it will not. For, taking the extreme cases, the power delivered by the amplifier to the speaker will be zero when the speaker impedance is either zero or infinite. And, for all values of speaker impedance between zero and infinity the power delivered by the amplifier will have any value between zero and a certain maximum. Consequently it becomes necessary to express the performance of an amplifier or section of transmission line in such a way that the number which is used to express its performance is determined solely by the amplifier or section, independently of the apparatus to which it is connected. This can be done by comparing the performance of the amplifier or section of line with the performance of an ideal transformer connected in place of it. The ideal transformer must have the optimum turn ratio

so that no loss of power attends the insertion of the transformer into the circuit.

The effect of the ideal transformer can be more easily visualized by first considering the simple series circuit of Fig. 1. This shows a generator of voltage  $V_1$  and internal resistance  $r_1$ , delivering power to a load  $r_2$ . The current in the load and the power delivered to it are given by

$$I = \frac{V_1}{r_1 + r_2} \quad P_2 = \frac{r_2 V_1^2}{(r_1 + r_2)^2} \quad (1)$$

It can easily be shown that the maximum amount of power will be delivered to the load when  $r_2$  is made equal to  $r_1$ . In such case the expression for  $P_2$  reduces to

$$P_2 \text{ max} = \frac{V_1^2}{4r_1} \quad (2)$$

It must be distinctly understood that  $V_1$  remains constant, just as we assume a constant voltage delivered by a telephone transmitter, or a constant field strength at the antenna connected to a radio receiver, or a certain constant voltage delivered by the detector to the audio amplifier.

Now, (1) expresses the power deliv-

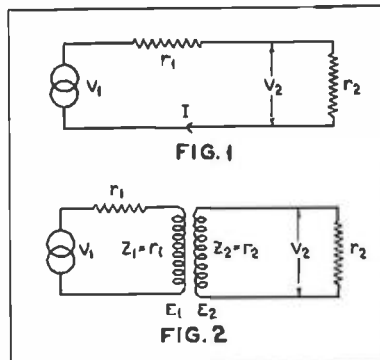

ered to the load under actual conditions, while (2) expresses the power delivered under ideal conditions. Consequently, the ratio of these expressions will express the inferiority or superiority of the actual circuit over the ideal circuit. Thus

$$\frac{P_2}{P_2 \text{ max}} = \frac{4r_1 r_2}{(r_1 + r_2)^2} = \frac{4 \frac{r_1}{r_2}}{\left(\frac{r_1 + r_2}{r_2}\right)^2} \quad (3)$$

Now, it will be noted that the fraction in the denominator is the voltage ratio, that is, the ratio of the voltage delivered by the generator to the voltage across the load terminals. That is,

$$\frac{r_1 + r_2}{r_2} = \frac{V_1}{V_2} \quad (4)$$

whence

$$\frac{P_2}{P_2 \text{ max}} = 4 \left(\frac{V_2}{V_1}\right)^2 \left(\frac{r_1}{r_2}\right) \quad (5)$$

The system of transmission units

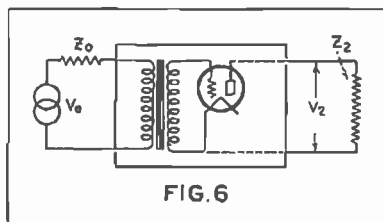

FIG. 6

expresses the ratio of two amounts of power logarithmically. The logarithm of (5) expresses the transmission loss in "dbs." This unit is, as a rule, too large for convenience, so the decibel, having a value 1/10th of the bel, is generally used. Then the loss in decibels is given by

$$L = 10 \log \frac{P_{max}}{P_2} = 6.02 + 20 \log \left( \frac{V_2}{V_1} \right) + 10 \log \left( \frac{r_1}{r_2} \right) \quad (6)$$

Equation (6) represents how much lower the power level at the load, expressed in decibels, is, than it would be if the impedances were matched and the load were receiving the maximum amount of power. Another way of looking at it is, that (6) represents how much improvement can be made in the power level at the load by equalizing the impedances.

Now, suppose that, instead of connecting  $r_1$  directly to  $r_2$ , an ideal transformer having the optimum turn ratio is interposed between them. This transformer has the following characteristics:

$$\begin{aligned} r_1 &= r_1 Z_1 = r_2 \\ \frac{I_2}{I_1} &= \sqrt{\frac{r_1}{r_2}} \\ \text{turn-ratio} &= \frac{E_2}{E_1} = \sqrt{\frac{r_2}{r_1}} \quad (7) \end{aligned}$$

$Z_1$  and  $Z_2$  are the primary and secondary transformer impedances,  $E_1$  is the voltage applied to the primary and  $E_2$  is the induced voltage in the secondary.

In Fig. 2 the voltage  $E_2$  is the same as  $V_2$ . The voltage  $E_1$  is half of  $V_1$  and the ratio of  $E_2$  to  $E_1$  is as given above. Then, the power in the load is given by

$$\begin{aligned} P_2 &= \frac{V_2^2}{r_2} = \frac{E_2^2}{r_2} \\ &= \frac{E_1^2 \left( \frac{r_2}{r_1} \right)}{r_2} = \frac{E_1^2}{r_1} \\ &= \left( \frac{V_1}{2} \right)^2 = \frac{V_1^2}{4r_1} \quad (8) \end{aligned}$$

Now, it will be noted that this expression is identical with (2). It is therefore clear that by inserting an ideal transformer having the optimum turn ratio into the circuit, the same effect is created as when the impedances are made equal to each other. Hence the term, "impedance matching transformer." In other words, if we start with circuit 1, the power supplied

to the load being  $P_2$  on inserting an ideal transformer the power in the load will increase to  $P_{2,max}$ . The loss in the circuit of Fig. 1, expressed in decibels, is given by (6) and is known as the transformer loss. This is the loss which is due to the impedance "mis-match" between the source of power and the load. The expression (3), from which (6) was derived, is the square of what is known as the reflection factor. Thus, the reflection factor existing between the two impedances  $r_1$  and  $r_2$ , is

$$\frac{\sqrt{4r_1 r_2}}{r_1 + r_2} \quad (9)$$

Fig. 3 shows the graph of (3), (5) and (6), all of which are identical.

Now let us consider whether (6)

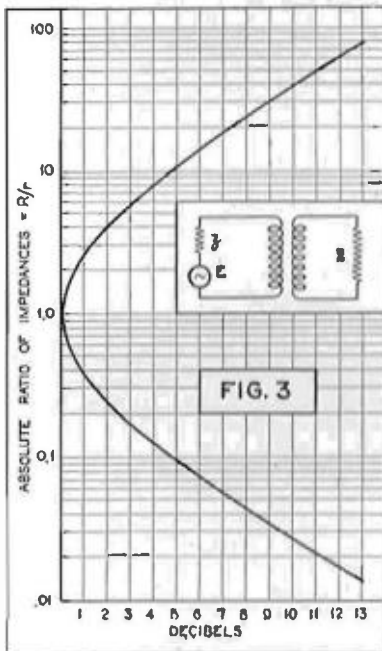

Fig. 3. Transformer loss curve. Showing gain obtained by inserting ideal transformer at junction of two circuits whose impedances are  $Z_0$  and  $Z_L$ .

can be applied to a complicated section of a transmission line, or to an amplifier. So far we have considered only a simple series circuit such as shown in Fig. 1. Now consider Fig. 4. A generator whose voltage is  $V_0$  and whose internal impedance is  $Z_0$ , feeds into a network whose input impedance is  $Z_1$ . This network delivers power to a load impedance  $Z_2$ . The voltage at the input of the network is  $V_1$ , and at the

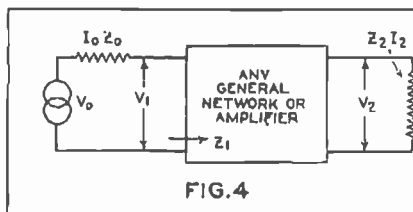

FIG. 4

output,  $V_2$ , so that the voltage ratio (or amplification) is  $V_2/V_1$ . The current delivered by the generator is  $I_0$  and the current in the load is  $I_2$ .

It is evident that the power delivered to the load is given by

$$P_2 = r_2 I_2^2 \quad (10)$$

The "transfer admittance" of the network may be defined as the ratio of the current leaving the network to the voltage impressed on its input, or

$$|Y| = \frac{I_2}{V_1} \quad (11)$$

The vertical bars enclosing a quantity indicate that the absolute value of this quantity is meant. This can be written as

$$\frac{I_2}{V_1} = \frac{V_2}{V_1} \frac{k}{|Z_2|} \quad (12)$$

in which  $k$  is the voltage ratio (or amplification).

Solving this for  $I_2$  and substituting in (10), the power in the load is

$$P_2 = r_2 \frac{|Z_1|^2}{|Z_0 + Z_1|^2} \frac{k^2}{|Z_2|^2} V_0^2 \quad (13)$$

If now, we substitute for the network an ideal transformer having the optimum turn ratio, making the circuit that of Fig. 5, the power delivered to the load will be

$$P_2' = \frac{V_0^2}{4r_1} \quad (14)$$

Taking the ratio of (13) to (14), and expressing it in decibels we obtain as the loss (or the gain, since if the loss turns out negative it may be interpreted as a gain) of the network the expression

$$L = 6.02 + 20 \log k + 10 \log \frac{r_0}{r_1} + 20 \log \cos \theta + 10 \log \frac{|Z_1|^2}{|Z_0 + Z_1|^2} \quad (15)$$

This may look rather formidable at first, but due to the way in which the terms are grouped the significance of each can easily be understood. For example, the first three terms are similar in form to those in (6), expressing the loss due to the mis-match of terminating impedances. The fourth term represents another loss due to the reactance of the load impedance. The last term represents that fraction of the generator voltage which is impressed on the input terminals of the network, since there is a drop in voltage in the internal impedance  $Z_0$ .

For the particular case where the network of Fig. 4 is an amplifier, the input to the amplifier is usually a transformer (see Fig. 6). Moreover,

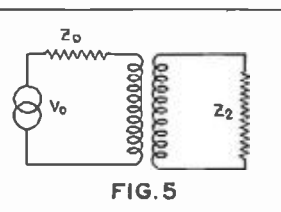

FIG. 5

age ratio  
The cur-  
ator is  $I_0$   
s  $I_k$ .  
-delivered  
(10)  
of the net-  
atio of the  
o the vol-  
or

(11)  
a quantity  
ue of this  
be written

(12)  
o (or am-  
substituting  
oad is

(13)  
e network  
the opti-  
he circuit  
livered to

(14)

(14), and  
obtain as  
f the loss  
be inter-  
work the

0 log cos  $\theta$ ,

(15)

midable at  
which the  
fificance of  
For ex-  
re similar  
expressing  
of termi-  
urth term  
o the re-  
nce. The  
action of  
h is im-  
ols of the  
p in vol-  
e  $Z_0$ .

where the  
ifier, the  
usually a  
Moreover,

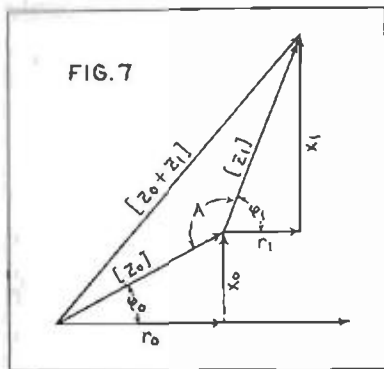
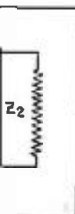

the terminating impedances  $Z_0$  and  $Z_1$  are almost pure resistances. Due to the fact that the transformer works into the infinite input impedance of a vacuum tube, the primary impedance of the transformer is very large compared with  $Z_{in}$  which is often the  $r_p$  of the detector tube of a radio receiver. Under such conditions the last term of (15) becomes negligible. Due to the non-reactive character of the load impedance the fourth term is also zero, whence the expression for the gain of the amplifier is simply

$$6.02 + 20 \log k + 10 \log \frac{r_1}{r_2} \quad (16)$$

Thus, in making measurements of the gain of an amplifier,  $Z_0$  is the  $r_p$  of the detector tube and  $Z_1$  is the resistance of the voice coil of the loudspeaker. The voltage ratio  $V_1/V_0$  is measured, and the gain is computed by (16). It must not be forgotten to add in the 6.02 decibels, which are often neglected by experimenters.

In cases where the input impedance of the network is not large compared with  $Z_0$  it is necessary to compute the last term of (15). This can be done with the aid of the vector diagram of Fig. 7. The angle  $A$  of the oblique triangle is

$$\pi - \vartheta_1 + \vartheta_0 = \pi - \beta$$

where  $\beta = \vartheta_1 - \vartheta_0$ .

Solving the oblique triangle

$$|Z_0 + Z_1| = z_0^2 + z_1^2 + 2z_0z_1 \cos \beta$$

in which  $Z_0 = z_0$  and  $Z_1 = z_1$ . Therefore,

$$\frac{|z_1|}{|Z_0 + Z_1|} = \frac{1}{1 + \left(\frac{z_0}{z_1}\right)^2 + 2\left(\frac{z_0}{z_1}\right) \cos \beta} \quad (17)$$

The angles  $\vartheta_0$  and  $\vartheta_1$  are the phase angles of  $Z_0$  and  $Z_1$ . Note that when  $z_1$  is large compared with  $z_0$ , this reduces to unity, the logarithm of which is zero, as mentioned before.

The necessity for determining the gain of an amplifier by the method described above can be seen from the following case. Suppose the gain of an amplifier, measured by this method, is found to be so many decibels. This is the gain that the amplifier has when there is no reflection loss between the

terminating impedances, that is, when the terminating impedances are equal. Now, when the amplifier is inserted between impedances which differ, a reflection loss occurs which may be obtained from the curve of Fig. 3. In addition to this, there may be other reflection loss due to mis-match at the input and output of the amplifier. For example, referring to Fig. 8, from the measured gain of the amplifier must be deducted the reflection losses occurring between  $r_0$  and  $r_1$ , between  $r_0$  and  $r_2$ , and between  $r_1$  and  $r_2$ , in order to obtain the actual gain of the amplifier in the circuit. If  $r_0$  and  $r_1$  are matched, and also  $r_1$  and  $r_2$  are matched, and also  $r_0$  and  $r_2$  are matched, the only reflection loss that remains is that between  $r_0$  and  $r_2$ . Thus, the performance of an amplifier whose gain is known with reference to the ideal circuit can be determined for any circuit simply by correcting for the mis-matches which occur.

In obtaining fidelity curves of amplifiers, or of complete radio receivers, it is not always necessary to know the actual magnitude of the gain, but simply the variation of the gain with reference to the gain which is obtained

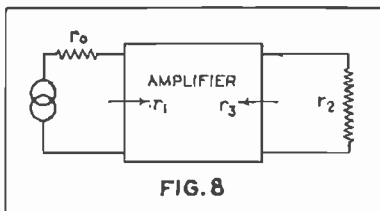

FIG. 8

at a given frequency. For example, assume a signal impressed upon the input terminals of a radio receiver. The carrier frequency and percentage modulation are held constant, while the modulating frequency is varied. The signal voltage impressed on the input of the detector tube is necessarily constant, avoiding a difficulty which would be introduced due to the square law of the detector if the signal at its input were permitted to vary. The power input to a resistance load representing the voice coil resistance is measured for various frequencies of modulation. Thus, if  $P_{400}$  represents the power in

the voice coil at a modulation frequency of 400 cycles, and  $P_f$  is the power at any other frequency, the expression  $10 \log P_f/P_{400}$  represents the variation of power in the load with reference to the power level at 400 cycles. The measurements may be obtained by simply measuring the voltage or current in the load. The equivalent expressions are

$$20 \log \frac{E_f}{E_{400}} \quad 20 \log \frac{I_f}{I_{400}}$$

since the power is proportional to the square of either the current or the voltage. In making such measurements, it is necessary to have calibrated instruments, either thermocouples or calibrated vacuum tube voltmeters, and where many such curves are required the process may become quite tedious, on account of having to consult the calibration curves, or checking the calibrations.

The work may be considerably simplified by using a thermocouple in series with a resistance which is large compared with the load resistance, as indicated in Fig. 9. The value of  $R$  need not be known, nor is a calibration curve of the thermocouple required. The power in the load is given by  $E^2/r$ . The current through the thermocouple is proportional to  $E$ , whence the power in the load is proportional to the current in the thermocouple. This, in turn, is proportional to the square of the meter deflection. Thus we have

$$P \propto E^2 \\ E^2 \propto I^2 r_a \\ I^2 \propto \delta$$

where  $\delta$  represents the meter indication. It is evident then that the power in the load is directly proportional to the meter reading. The variation of power in the load may then be directly determined by taking the ratio of the meter reading at any frequency to the meter reading at 400 cycles, and then obtaining 10 times the logarithm of this ratio. It is often necessary to make many measurements of power output of the power amplifier tubes. This problem may be simplified by using the arrangement

(Concluded on page 34)

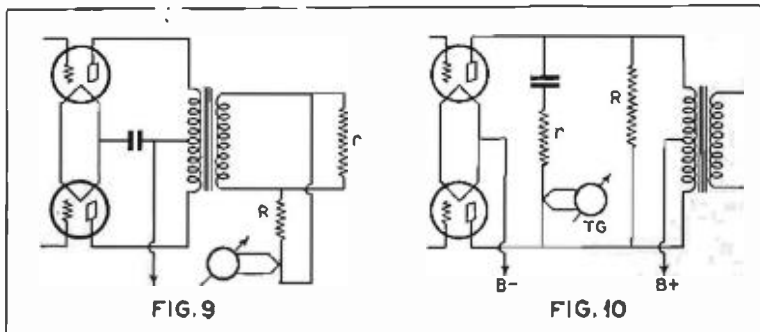

FIG. 9

FIG. 10



# Accuracy of Measuring Instruments

By A. J. LUSH\*

CONSTANCY of calibration is one of the requisites of a good meter. There are various factors governing this, such as permanency of magnetic flux, quality and temper of springs used, freedom from outside-of-meter disturbances, good joints in the electrical circuit, variable temperatures changing both the electrical resistance of the circuit and also the actual linear dimensions of the pivot settings on the movement itself, but perhaps a feature which has not been previously emphasized on account of difficulties of construction, is the actual position taken by the pivots upon which the movement turns.

It is not the purpose of this article to apply this reasoning to meters of the vertical type as these are usually hung in a fixed position when calibrated and used in a similar position only, but when meters are intended for portable use or for horizontal use, such as in test sets, the meter can not be guaranteed to be placed in exactly the same relative position or level as when originally calibrated. It is here where position of pivots within their jeweled bearings is of vital importance. Any other position taken by the movement other than that in which it was calibrated will very obviously affect the constancy of calibration.

\* President, Rowson Electrical Instrument Co.

▲  
Modern instruments are provided with improved method of movement pivoting

Four different methods of pivot mounting are shown in the illustrations. Figs. 1, 2 and 3 show the older methods. Figs. 1 and 2 can be relied upon where there is a strong control necessitating a strong spring which in turn tends to hold the movement in a definite position, but this is not the case where high

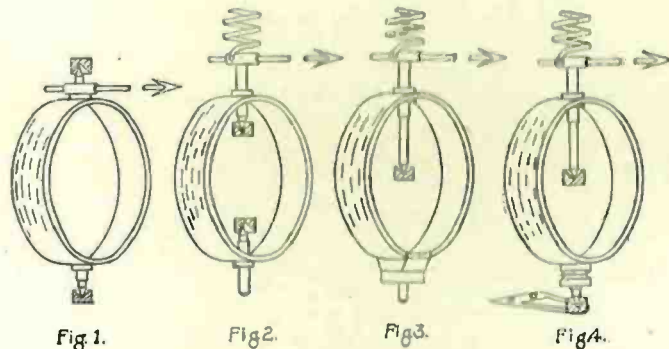

sensitivity is desired say below 1 ma. full scale. Reference to Fig. 1 will show the lower pivot which supports the weight of the movement to be resting on its extreme tip and in contact with the apex of the jewel bearing which is of course as it should be, but observe the unstable position of the top pivot which merely acts as a guide. On account of the impossibility of tightening the top jewel to bring pivot to apex of bearing this pivot is liable to wobble around within the area of loose fitting of pivot to jewel. This can not be avoided, as, should the jewel be tightened very undesirable friction would immediately appear. Furthermore, a feature which is sometimes lost sight of is the linear expansion and contraction of the whole moving coil which of course includes the dimensions between pivots, due to changes in temperature. This latter condition has been the cause of trouble in the past evidenced by the movement sticking when meters have been used at varying temperatures. To

avoid this entails loosening the fit of pivots to jewels. One more feature must be considered; that of total frictional moment which may be considered in simple form as  $=\frac{2}{3} uWr$  where  $u$  is the coefficient of friction for the materials used,  $W$  the weight and  $r$  the radius of surface contact. While the lower pivot carries the greater portion of the weight,  $r$  is at the lowest value possible as the movement is resting on the extreme point of pivot, the only measurable surface being due to the crushing effect of the movement weight (a good hard pivot and high quality well polished jewel will reduce this to a minimum). The upper pivot, however, while only carrying a small portion of the weight, has an enormously larger "r" rolling around within its loose area of contact. Hence in order to overcome frictional trouble a much stronger control is necessary. This is usually attained at the expense of clearances within the gap in which the movement turns with its detrimental feature of causing sticking of movement on sides of gap or on minute particles of dust, but if given the larger clearances movement would easily ride over without touching.

The above remarks apply equally to the movement shown in Fig. 2, with the exception that in this case the top pivot carries most of the weight and the bottom pivot wobbles around.

Fig. 3 shows the single pivot movement which eliminates the

loose fitting second pivot feature and includes the addition of its adaptability to clamping for transit, which, by lifting the weight of the movement relieves the pressure between pivot and jewel. All clamping has for its aim the protection of pivots from damage while being shipped. So called electrical clamping which is a device for short circuiting the moving coil, will not take care of this as it protects only the pointer from bending due to excessive slamming, the weight of the movement being still carried by the pivots.

Some time ago the writer was confronted with the problem of developing a high sensitivity electrostatic voltmeter. Anyone familiar with this type of meter will recognize that every one of the above remarks play a very important part therein. In line with this he devised a means of eliminating the detrimental features while still retaining the valuable clamping feature. A single pivot movement was out of the  
(Concluded on page 30)



# Individual Radio at Last

A "SINGING" and "talking" radio pillow for use in hospitals and Pullman cars has just been developed by the Engineering Products Division of the RCA-Victor Company, Inc.

The radio pillow is of regulation hospital size, and is made of specially selected sponge rubber in which a sensitive radio reproducing unit is concealed. It is so constructed that although the sound permeates the pillow it cannot be heard except by resting the head on the pillow. The RCA radio pillow was designed especially for use in hospitals to replace ordinary earphones which become irksome and

chafe when worn for any length of time. The loudspeaker is often impracticable too, because the radio programs may be disturbing to other patients in various stages of illness.

The new pillow, according to its

sponsors, may be sterilized like an ordinary pillow, and the pillow-cases changed at will. The patient lies in a natural reclining or sitting-up position to hear the radio programs. A connecting cord of ample length is plugged into the centralized radio receiving system.

The engineers who developed this latest device, expect new applications to suggest themselves continually. For instance, it is pointed out that the radio pillow may be used to relieve the tedium of long travelling in the Pullman cars, or to divert sea travelers resting in steamer chairs or berths.

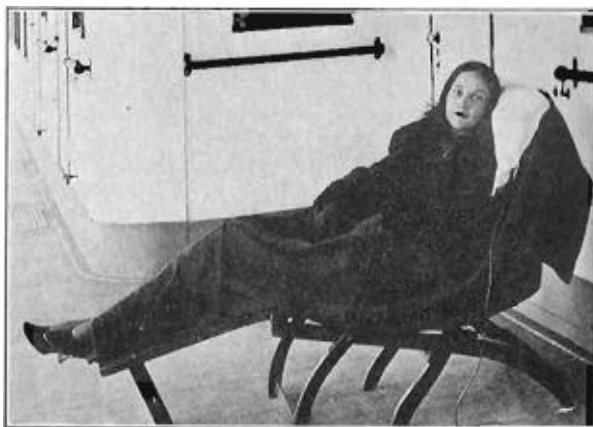

Individual radio receiver.

Not Only in Hospitals, Pullman Cars, and on Shipboard, but may be the answer to Family Disputes in Regard to Preferred Programs.

## Federal Radio Commission Issues New Orders

EFFECTIVE March 1, 1931, General Order No. 105, of the Federal Radio Commission, goes into effect. This order contains the following provisions:

**Section 1. The Broadcasting Day.** That period of time between six o'clock, a.m., and twelve o'clock midnight shall constitute a broadcasting day; the period between six o'clock a.m., and local sunset to be designated as daytime and that between local sunset and twelve o'clock midnight as nighttime. The monthly average sunset at all locations will be specified by the Federal Radio Commission and the references herein made to times shall be taken as referring to local standard time unless otherwise ordered. In determining the quota value of a given assignment or in the computation of time division the average time of local sunset shall be taken to be six o'clock p.m., and one hour of nighttime operation shall be considered as the equivalent of two hours of daytime operation.

**Section 2. The Test or Experimental Period.** That period of time between twelve o'clock midnight and six o'clock

a.m., local time, shall constitute the test or experimental period and may be used for this purpose by any regularly licensed broadcasting station on its assigned frequency and with its authorized power; provided, however, that no interference is caused with other stations maintaining a regular operating schedule during all or any part of said time.

**Section 3. Unlimited Time Stations.** All broadcasting stations now or hereinafter licensed to operate without limit as to time may operate on any schedule of hours that meets their requirements whether during the broadcasting day or test or experimental period; provided, however, that from and after the 1st day of May, 1931, no licenses authorizing unlimited hours of operation will be issued to broadcasting stations which are not on said date and do not continuously thereafter maintain a minimum regular operating schedule of twelve hours per broadcasting day; at least three hours of which shall be between six o'clock p.m., and twelve o'clock midnight local time. In all cases where the minimum regular

operating schedule herein provided is not adhered to, such stations may after hearing be required to share time with other stations or be reduced to part-time stations.

**Section 4. Stations Sharing Time.** (a) In all cases where broadcasting stations are licensed to share time they shall not operate simultaneously at any time, either day or night, unless specifically authorized to do so by the terms of their licenses.

(b) In all cases where broadcasting stations are licensed to share time and specified hours of operation are designated in the license, that schedule shall be adhered to until otherwise ordered by the Commission or deviation therefrom is permitted pursuant to paragraph (d) of this section.

(c) In all cases where broadcasting stations are required to share time and the specific hours of operation are not designated in the license, the licensees of such stations shall endeavor to reach an agreement as to a definite schedule of periods of time to be used by each of them and if successful each of said stations shall reduce said agreement to

writing and file the same in triplicate with the Commission with each application for renewal of license. If and when such written agreements are properly filed in conformity with this order, the file mark of the Commission shall be affixed thereto, one copy shall be retained by the Commission, one copy shall be forwarded to the Radio Division of the Department of Commerce, and one copy shall be returned to the licensee of said station to be posted with its license and considered as a part thereof. If the license specifies a definite proportionate time division the agreement shall maintain this proportion. In cases no proportionate time division is specified, the stations will agree upon a division of time. Nothing contained in this order shall be construed as authorizing or permitting the simultaneous operation of such stations unless specifically authorized to do so by the terms of their licenses.

(d) In all cases enumerated in Paragraphs (b) and (c) hereof, departure from the regular operating schedule will be permitted only in cases where an agreement to that effect is reduced to writing, signed by the stations affected thereby, and filed in triplicate with the Commission prior to the time of said departure; provided, however, that in cases where time is of the essence the actual departure in the operating schedule may, after appropriate notice to the Commission and to the Radio Division of the Department of Commerce, precede the actual filing of the written agreement with the Commission; and provided further that nothing herein contained shall be taken as authorizing any simultaneous operation not specifically authorized in the licenses of the stations affected.

(e) In all cases enumerated in Paragraph (c) hereof where the station licensees are unable to reach an agreement as to a definite schedule of periods of time to be used by each of them, the Commission shall be so notified by the filing of a statement to that effect with the application for renewal of license. Upon receipt of such statement the Commission will designate the applications for hearing and pending such hearing the operating schedule previously adhered to shall remain in full force and effect.

**Section 5. Limited Time and Day Stations.** (a) In all cases where a broadcasting station is licensed to operate limited time or during daytime it shall not operate simultaneously with any other station assigned to that frequency at any time unless specifically authorized to do so by the terms of its license.

(b) In all cases where a broadcasting station is licensed to operate with limited hours and required to cease

operation at the time of sunset at some point within the United States, the license will provide the hour of the day during each month of the license period when said station shall cease operation.

(c) In all cases where limited time stations are licensed to resume operation at the time the unlimited time station on the same channel ceases operation, the licensee of said limited time station shall file in triplicate with the Commission a copy of its regular operating schedule, signed and approved by the licensee of the unlimited time station. Upon receipt of such operating schedule, properly executed, the Commission will affix its file mark, retain one copy, forward one copy to the Radio Division of the Department of Commerce, and return one copy to the licensee of the limited time station filing the same who shall cause it to be posted with and considered as a part of the station license. Departure from said operating schedule may be had only by compliance with the provisions of Paragraph (d) of Section 4 with respect to such departures by stations sharing time.

**Section 6. Reducing Power at Sunset.** In all cases where a broadcasting station is licensed to operate with more power during daytime operation than for nighttime operation and the licensee is required to reduce the power of the station at the time of sunset, the license issued to said station will specify the hour of the day during each month of the license period at which said station is required to reduce its power.

**Section 7. Part-Time Stations.** Any broadcasting station other than a day or a limited time station which is licensed to operate part-time on a channel where the entire available broadcasting time (i. e., the broadcasting day) has not been designated for the use of any other station or stations, may operate temporarily and until the further order of the Commission upon all or any part of the time not so designated; provided, however, that where two or more part-time stations are eligible to operate on said undesignated time, they shall comply with the provisions of Paragraph (c) of Section 4 with respect to the regular operating schedule of stations sharing time.

**Section 8. Violations** (a) In all cases where a licensee is required by the terms of this order to file any document pertaining to its operating schedule at the time of its application for a license, the failure to file such a document shall be considered as a defect in the application for license within the meaning of Section 1 of sub-title B of "Practice and Procedure before the Federal Radio Commission" adopted by General Order No. 93.

(b) In all cases where a station licensee is required to prepare and file a

regular operating schedule, any deviation or departure from such schedule, except as herein authorized, shall be considered as a violation of a material term of the license and of this order.

(c) In all cases where the specific hours of operation are fixed in the license, any deviation or departure therefrom, except as herein authorized, shall be considered as a violation of a material term of the license and of this order.

(d) Unless specifically authorized to do so by the terms of their licenses, no stations operating on the same frequency assignments shall be permitted to operate simultaneously. Any unauthorized simultaneous operation shall be considered as a violation of a material term of the station license and of this order without regard to any understanding or agreement as between the stations affected thereby.

## ACCURACY OF MEASURING INSTRUMENTS

(Concluded from page 28)

question on account of the possible sideways or oscillating motion which is not a serious objection on that type of movement, as the pivot being in the center of a spherical magnetic field, all parts of the deflection coil remain at equal radii distances in the field at all times. The principle of balancing the whole of the movement weight on one central pivot was retained, with another pivot added to act as a guide which, however, would at all times be in contact at its extreme point with the apex of the jewel bearing. This latter feature being attained by supporting the jewel on a very resilient but weak spring incapable of supporting the weight of movement. On account of special construction this spring could not move in a lateral direction being limited upwards by the pivot and downwards slightly below the hanging point of pivot by a solid stop thereby eliminating the possibility of jumping out of reach of the pivot. As both pivots were in the same direction or downwards this permitted design of a clamping device similar to that used on the single pivot movements. When unclamped, relative position of pivots in both bearings was maintained as both pivots were in intimate contact with the apex of their jewel bearings thereby removing any possibility of calibration error due to a variable change of position of moving element. Later the same principle was applied to the Rawson fluxmeter and then to the regular line of micro and milliammeters, where it has lent itself to removing the up and down motion characteristic of the single pivot movement.

Fig. 4 shows the latest arrangement of this development on the standard Rawson microammeter movement.

# World Market for Radio Equipment

**S**ELECTIVITY is a primary requisite in radio sets designed for use in Europe, according to Lawrence D. Batson in an analysis of world markets for radio equipment which the Commerce Department has just released. In the United States, Mr. Batson points out, the system of chain broadcasting whereby identical programs are broadcast by large stations in various parts of the country makes this attribute of lesser importance. In Europe, on the other hand, there is little or no chain broadcasting; the large broadcasting stations enjoy absolutely clear channels and the radio fan is able to choose his entertainment from a wide field of programs coming from many different countries.

More than twenty-four million radio sets, representing a value of approximately one-and-a-half billion dollars, are in use throughout the world today, Mr. Batson's report reveals. Forty-five per cent of the world total, or 10,500,000 sets, with a value of \$676,000,000, are in the

United States. The total investment in broadcasting stations throughout the world is estimated in the neighborhood of \$29,000,000, of which one-half is represented by stations in this country.

Socket-power sets account for 52 per cent of the total number in use in North America, for about one-half of the sets in Europe, and one-quarter of those in South America. Crystal sets are fewest in North and South America, representing 1 and 2 per cent respectively, and highest in Russia and Turkey where the ratio is around 20 per cent.

In the majority of countries outside of the United States and Canada, the cost of broadcasting is paid by a system of license fees levied on the radio sets in use. These fees range from as low as 39 cents in France to as high as \$44 per set in Turkey. The average license fee, however, runs between \$3 and \$4. As there are approximately 11 million radio sets in Europe, it is apparent that the amount paid yearly by radio fans in that area is between

forty and forty-five million dollars. According to Mr. Batson, there is a definite trend in some foreign countries toward adopting the American system of a sponsored program. Most foreign countries, however, prefer to retain the license fee system, having a prejudice against mixing advertising with radio entertainment.

Referring to the type of foreign broadcasting programs, the report shows that a sort of "universal" program has been adopted similar to that used in the United States, consisting of music, addresses, and informative talks. Even sports and news events are now put on the air by foreign stations, although not to the extent prevailing in this country.

American radios, according to Mr. Batson, are generally regarded as superior to the great majority of foreign makes. In European manufacturing countries, his report shows, most of the sets in use are of domestic origin. After the United States, England and Germany have made the greatest advance in radio development and each has built up a substantial export trade in radio sets and equipment.

The United States today is the world's largest exporter of radios and during the last three years has made striking gains in this field. Foreign sales rose from something more than \$9,000,000 in 1927 to \$12,000,000 in 1928, while the export figure for 1929 was more than \$23,000,000.

## One Hundred Percent Tubes Only Go to Dealers

▲

The photograph here reproduced shows the dump-heap accumulation of tubes in the rear of the manufacturing plant of the Sylvania Products Company, Emporium, Penna. In the process of test all tubes which do not meet the exacting specifications of the Sylvania Company, automatically become rejects and find their way to the dump, where they are destroyed.

▼

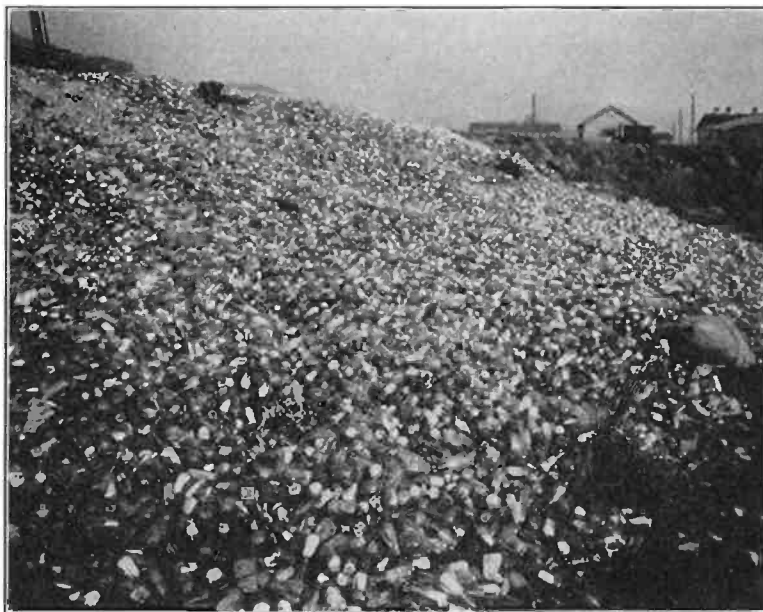

# What Shall We Do for 1931 Sets?

BY AUSTIN C. LESCARBOURA

Mem. I.R.E. Mem. A.I.E.E.

**W**HAT shall we use for talking points during the 1931 radio season? Last year we featured tone control, the year before the screen-grid tube, and two years ago the foolproof a-c. set. While trade and industry await the radio stylist's decision, it may be well to look around the laboratories and see just what is available by way of innovations and refinements.

It is rather doubtful that any radical innovation will be sprung on the radio industry. There may be important developments under way in the laboratories. We know of highly significant superheterodyne developments in the making, of better detector circuits, of tuned audio systems, and of sharper tuning systems permitting of dividing the broadcast band into five times as many channels. However, there is little danger of any monkey-wrench being thrown into the radio works for the reason that the industry is strongly entrenched behind standardization. No one dares upset the apple-cart, although logical improvements and refinements are very much in vogue.

## New Development in Tube Art

First of all, let us consider tube possibilities as the basis for 1931 radio styles. The outstanding development now in sight is a duo-gain or high-low gain screen-grid tube. This tube incorporates a split control grid which permits it to function automatically as a high or low gain tube according to the signal strength. In radio reception terms, this new tube permits of excep-

tionally high gain for maximum sensitivity in conjunction with weak signals, while automatically lowering the gain when powerful signals are to be handled, thereby overcoming the present overloading tending in highly sensitive circuits. The tube will also make for greater selectivity in tuned r-f. circuits, thereby eliminating the usual pre-selector circuits.

Already we have available the high-gain screen-grid tube, which provides approximately twice the gain of the usual -24 type. This tube has met with immediate favor in midget sets, where greater sensitivity is frequently required. It is evident that the high-gain screen-grid tube will become the standard type in time, with greater efficiency for the usual screen-grid set.

There are several heater types in the laboratories for use on 110 volts d-c. or a-c., 32 volts d-c. as in the usual isolated power plant field, and 6 volts d-c. as in automobile radio work. The -30 series of 2-volt tubes, introduced early last year, is bound to come into general use, particularly with new battery sets which will be introduced for use in homes beyond electric service.

## The Pentode Tube

The pentode which has been the object of more talk than action, may come into use, particularly in midget sets. Aside from the r-f. pentode introduced some time ago, there is promise of an a-f. pentode capable of real output with minimum of equipment and cost. Certainly in the struggle to achieve still lower prices without sacrificing performance standards, the pentode is a most attractive proposition to designers of midget sets.

The coming season will see the continuation of the battle between midget and standard sets. It is estimated by those "in the know" that the midget sets will total two-thirds of all sets sold.

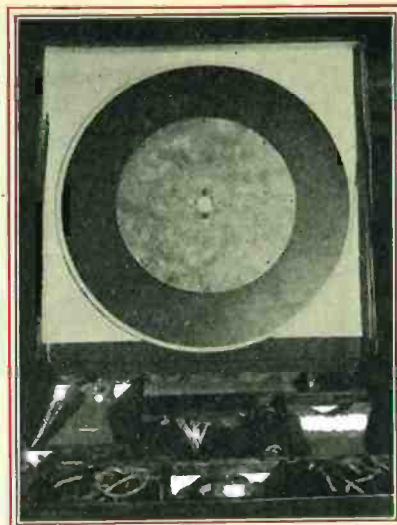

Television attains the merchandising stage—typical kit of parts for assembling a radiovisor.

but we are frankly doubtful of that prophecy. It seems to us that during the past month or two, the tide has definitely swung away from midget sets. Of course this may be due in part to the slashing of prices on standard sets, but even so, more standard sets in proportion are being sold now even at full list prices than was the case a few months back.

No doubt the midget sets will be vastly improved. In many laboratories the technicians are hard at work on ways and means of trimming costs. New power packs have been developed in which the components and costs are reduced to new levels of economy. The Loftin-White direct-coupling audio amplifier and variations thereof will come into greater use. Important loudspeaker developments will tend to enrich the tone of the diminutive loudspeaker of the midget.

The pace forced upon the standard set by the midget will result in marked improvements in higher priced sets. Tone quality is the initial point of attack. Here is where the standard set can out-perform the midget set in the most obvious manner from the average buyer's standpoint. Loudspeaker designers have been hard at work on tone improvements, especially in the matter of better diaphragms. Recently, some important work has been done on special paper diaphragms with odd rim patterns to provide remarkable flexing properties. These paper diaphragms are less costly than anything yet employed, entirely self-contained so as to eliminate costly mounting or masking, yet provide the finest tone quality yet attained. The impregnated cloth diaphragms have also been improved, but their costs are apt to prove excessive in view of the low list prices that are certain to obtain.

▲  
Betterment of Vacuum Tubes  
Will Be Taken Advantage  
of This Year



### Combination Sets

There is every indication that the combination phonograph-radio set will be most popular. After all, the phonograph feature does not add greatly to the cost of the console set and yet has a far greater sales appeal than the plain radio set. The recent introduction of the home recording feature, which is based on the availability of the phonograph-radio combination, gives new life to the combination set. The fact that the home recording feature may be employed for recording either home talent, through a microphone, or any desired radio program, makes the combination set far more attractive than ever before. It is freely predicted that combination sets selling from \$116 to \$149 will be popular this coming season. The special records for home recording will be available in a range of sizes, selling for as little as 20 cents each.

### Automobile Radio

In seeking a greater volume of business so as to compensate for the decline in sales dollars due to lower priced units, the automobile set looms up as a strong possibility. Rumor has it that at least one company is to have an automobile radio set selling for \$65 or less, which makes this radio application feasible. A year ago, an automobile radio set sold for better than \$100. New design, together with special tubes, will tend to make automobile radio practical, while a low list price will make it popular.

Still another means of increasing the sales figures may be forthcoming in the form of so-called individual radio sets. Recently, one manufacturer has introduced a two-tube a-c. set for headphone operation, which provides private reception for any individual. Such a set is proving quite popular, since it can be employed in the home as a receiver sep-



The individual receiver with two tubes, fully a-c. operated, provided with headphones.

arate from that of the household, at school, in the hotel, for the hospital, on trips, in the office, and so on. There is real need for the individual receivers, now that the radio habit is so firmly instilled in most of us. It is just a matter of price, and with \$25 already attained, the industry is quite likely to go far below that figure in gaining public acceptance for the individual receiver idea.

There may be a serious attempt made to build up a line of accessories for the usual radio set. Home recording, remote loudspeakers and home talkies are logical accessories for which the set designer may provide the necessary jacks and switches. This would be a boon to the radio trade which, since the advent of the self-contained radio set, has gained simplicity of initial selling only at a sacrifice of those repeat sales that would accrue through proper provision for accessories.

### Home Talkies

Home talkies are an immediate possibility, since the development work on the film-disc type has been completed. While most of the offerings are designed around the usual elaborate 16 millimeter film projector, with a suitable flexible-shaft-driven disc turntable added, some interesting work has been done in conjunction with a motor-driven turntable driving a very much simplified projecting mechanism by means of flexible shafting, or just the reverse of the usual projector with a turntable accessory. Certainly costs are going to be greatly reduced in this field, for radio manufacturers are going to provide complete home talkie equipment at but a fraction of the costs that have heretofore obtained in the home movie field. The usual radio set will be employed, of course, for the sound reproducing end. Sound-on-film home talkies, representing the ultimate ideal, are still a long way from realization. Engineers have found it impractical so far to crowd satisfactory sound records on the diminutive 16-millimeter film, 400 feet of which is equivalent to 1000 feet of standard film.

Last season we had tone control. There are evidences that the industry may go further in the matter of tone control. The writer has recently enjoyed a demonstration of the tone control method developed by a well-known radio worker. In a power amplifier including this system, the operator has a variety of control knobs covering more or less bass, more or less treble, gain, and even variable scratch filtering in the case of phonographic reproduction. It is possible to obtain any desired reproduction with such a control board, thereby fitting the loudspeaker rendition to room acoustics, selection and personal tastes. It is quite possible that

some of the finer offerings will include a more elaborate tone control of this general nature.

Automatic line voltage regulation is receiving considerable attention just now, since no little grief has been encountered in many sections of the country regarding fluctuating line voltages. The automatic line voltage control is in reality nothing more than a suitable form of ballast or self-adjusting resist-



New Columaire radio receiver of Westinghouse.

ance in the primary circuit of the power-pack transformer, which serves to keep the applied voltage within the narrow limits specified by set and tube manufacturers for best results. So far as production costs are concerned, the automatic line voltage regulator is simply an additional socket on the chassis, to take the ballast. Meanwhile, this socket does away with the usual tapped primary winding, so that the cost is more than cancelled by the saving. The ballast is added to the tube equipment.

The big feature of 1931 radio products will be new low prices. The American public will be price conscious about all luxuries quite as well as necessities, and will buy only at a bargain figure. Hence set designers must work to lower prices, which means no little ingenuity not only on their part but also on the part of component manufacturers. Many corners are being trimmed on components, so as to meet the close prices indicated by set manufacturers. In the matter of filter condensers, for example, the industry is going electrolytic. Paper condensers will be sparingly used in the larger capacities. Compact, standardized, inexpensive metal cartridges, containing electrolytic condensers, are now available at one-fifth the price of paper condensers for a given capacity. Wire-wound resistors are being replaced by non-wire resist-



ors frequently mounted in gangs, at a fraction of the cost of former voltage-dividers. And likewise with other components.

#### Automatic Time Switch

One refinement which has not yet been introduced in standard sets is the automatic time switch. In its simplest form, it need be nothing more than a switch that will automatically turn off the radio set after a given time, so that the family, leaving the radio turned on for the purpose of being lulled to sleep, may be sure that the set will be automatically turned off. Such time switches are now available for as little as \$2.50 list, or probably \$1 or less in quantities. Elaborate time switches capable of turning sets off and on at specified times are also available. It is not unlikely that some radio set manufacturer may decide to have a time switch feature including the automatic selection of desired programs, so that an entire evening of selected entertainment from different stations may be enjoyed without touching the tuning controls of the set. This feature is even

more desirable than the remote control feature already in use and promising to gain ground this coming season in the more elaborate offerings.

As for cabinets, it may be well for the industry to get away from the console cabinet design which is essentially a radio job. In its present saving mood, the public may be more willing to consider a dual purpose radio cabinet which is at once a desk or table or bookcase quite as well as a radio set. A year or two ago, the public could buy a radio set *plus* some other piece of furniture. But in these times of economy only one piece of furniture can be bought, and whatever radio set serves both functions may be that much more desirable. It is to be hoped that our radio stylists will give some thought to cabinet design, getting away from the usual console cabinet which has outlived its original attractiveness.

#### Television

Television is a 1931 sales possibility. Despite what some would have us believe as to the insignificance of present television technique, the fact remains



#### RADIO MANUFACTURERS FROM ENGLAND VISIT U. S.

THE following prominent British radio manufacturers arrived in New York on the Aquitania on February 25. R. Milward Ellis, chairman of the Radio Manufacturers Association of London; T. A. W. Robinson, managing director of Pye Ltd., Cambridge, England; C. O. Stanley, sales and publicity consultant to several of the largest European concerns including Philips of Eindhoven, Holland.

The visitors are making their headquarters at the Ambassador Hotel, New York.

#### HERE IS WHERE THE MONEY WENT

There were 1,002,000 electric refrigerators sold in the United States in 1930, of which seven hundred seventy thousand were household equipments.

#### DESIGN TESTS FOR AMPLIFIERS AND COMPLETE RADIO RECEIVERS

(Concluded from page 29)

shown in Fig. 10. The secondary of the output transformer is opened, so that the transformer presents an enormous impedance to the tubes. Between the plates of the tubes there is connected a resistance  $R$ , of such value as to match the tube impedance,

or twice as great. If we are using 245 tubes, and are interested in the maximum power output,  $R$  is 4000 ohms; if we are interested in the maximum undistorted power output  $R$  is 8000 ohms.

The resistance  $r$  is to be very large compared with  $R$ . In other words, the resistance  $r$  and the T.G. constitute a voltmeter. The calibration curve of the T.G. is a parabola; that is, the T.G. is a square law device. The relation existing between the meter deflection and the current in the couple is given by  $d = kI^2$ , where  $k$  is a constant. The value of  $k$  can be determined by inserting in this relation the value of the current for any given meter indication, obtained from the calibration curve of the T.G. Then we have the following relations:

$$\begin{aligned} P &= \frac{E^2}{R} \\ &= \frac{(rI)^2}{R} = \frac{r^2 I^2}{R} \\ &= \frac{r^2 \left(\frac{d}{k}\right)}{R} = \left(\frac{r^2}{kR}\right) d \end{aligned}$$

$P$  is the power supplied by the tubes,  $I$  is the current in the thermocouple, and  $d$  is the meter indication. Note that the power is directly proportional to the meter reading.

This means that if the proper values are chosen the instrument can be used as a direct reading wattmeter. For

example, suppose a thermocouple is used, which gives full scale deflection with a current of 2.5 milliamperes passing through it. Suppose also the scale is graduated uniformly from zero to 200. The value of  $k$  is then  $200 / (2.5 \times 10^{-3})^2$  or  $32 \times 10^6$ . Suppose also that  $R$  is 4000 ohms and that it is desired to measure powers up to 20 watts. Then the value of  $r$  required is

$$\begin{aligned} r &= \sqrt{\frac{PRk}{d}} = \sqrt{\frac{20 \times 4000 \times 32 \times 10^6}{200}} \\ &= 113200 \end{aligned}$$

In order to be exact, the resistance of the T.G. itself should be deducted from this. In the present case it was 550 ohms, which makes the required value of  $r$  equal to 112,650 ohms. A reading of 200 on the scale then meant 20 watts; a reading of 100 meant 10 watts, and so on. Note in Fig. 10, the large blocking condenser, required to keep direct current from the B supply out of the thermocouple.

#### ANTENNAS

In the April issue of RADIO ENGINEERING will appear an instructive article on radio antennas, dealing with design and with transmission requirements.

Dev  
Art

The i  
servic  
bring

W  
in  
m  
sp  
things, for  
speed in get  
other, for s  
ributing in  
that this de  
and that it  
before the c  
la responsib  
ation.

The earli  
tribution o  
mouth, fir  
form today  
more defin  
form of de  
definitely a  
messengers  
in the inte  
Then came  
age which  
messenger  
messenger  
layed mess  
able man  
early con  
may term  
of convey

(Present  
December 1  
5 Ash  
Telegraph.

the market, the experience of radiovisors, its on the manufacturer of started movement through with fair success, er is ready and jobbing of ready-to-parts. How- into the average set have no business. Tele- entirely sepa- merchandising me to come, ive set man- and it to their some of the e very near

upon in pro- with a fresh- coax a tight- money in new

armocouple is ale deflection milliamperes pose also the ormly from of k is them 2 x 10<sup>6</sup>. Sup- rms and that powers up to of r required

x32 x 10<sup>6</sup>  
00

resistance of educted from e it was 550 required value ns. A read- men meant 20 10 meant 10 n Fig. 10, the required to the B supply

of RADIO ppear an on radio th design a require-

# Developments in the Art of Telegraphy<sup>†</sup>

By R. B. STEELE \*

The introduction of carrier current signaling in modern service by the large commercial telegraph companies, brings vacuum tube engineering and communication engineering closer together

**W**E speak today of the many inventions brought about by man's insatiable desire for speed, for speed in making things, for speed in doing things—for speed in getting from one place to another, for speed in collecting and distributing information. History tells us that this desire for speed is not new and that it is this desire, existing even before the days of written records, that is responsible for telegraphic communication.

The earliest legends tell us of the distribution of information by word-of-mouth, first in the form of what we know today rumors and later, when more definite requirements arose, in the form of definite messages conveyed by definitely appointed messengers. These messengers were first on foot, but later in the interests of speed were mounted. Then came the day of the written message which could be handed from one messenger to another and relays of messengers were used. But, even a relayed message carried in the fastest possible manner was too slow and some early communication engineer, if we may term him such, conceived the idea of conveying messages by means of sig-

nal fires and columns of smoke which could be observed from a distance. Signals so conveyed were infinitely faster than the best mounted messenger and this scheme of signaling by means of fires may be considered to be the first telegraph.

Signal fires took time to build, however, and the number of signals that could be conveyed by this means was limited. Other schemes were worked out in the attempt to increase the speed, flexibility and reliability of these early

telegraph systems and these schemes ranged all the way from groups of characters or letters, set up on high points where they could be observed from a distance, to light signals, flags and peculiar windmills with adjustable arms.

One of the earliest telegraphs of which we have now a direct representative, was a system of flag signals introduced about the middle of the seventeenth century by the Duke of York (afterwards James II of England) who was at that time admiral of the English fleet. This scheme was introduced for the purpose of directing the manoeuvres of the fleet and modifications of it are still in use in practically all navies in the world.

## Chappé's Telegraph

One of the most successful of the telegraph systems of the pre-electrical era made use of a mechanical device conceived and built by two French college boys. The boys, Claude and Ignace Chappé were attending a college at which they lived and studied in different buildings and where the rules forbade communication between the residents in these different buildings. As college boys do even today, they resented this restriction and set about finding a way of getting around the rule. Their efforts resulted in the construction in 1784 of a signaling device consisting of a horizontal arm mounted on the top of a pole and equipped with two movable arms, one of these hinged to each end of the horizontal arm in such manner that the two movable arms could be set at various angles with respect to each other and to the horizontal arm. With this device the brothers were able to make nearly 200 distinct signals and by means of two of these devices, each so displayed as to be visible to the other building, and a pre-arranged code, they were able to carry on conversations.

This telegraph system of the Chappé brothers was so successful that about

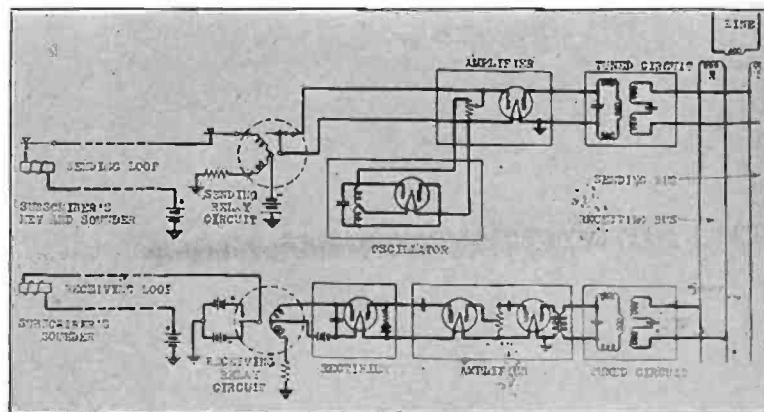

Fig. 1. Type B carrier telegraph. Essential elements of a single channel terminal.

<sup>†</sup>Presented before the Radio Club of America, December 10, 1930.  
\* Chief engineer, Canadian National Telegraphs.

1794 the French government adopted it and retained Claude Chappé as chief telegraph engineer to set up an extensive system of these semaphore stations. A modification of this semaphore signaling device is in use along many railway tracks today for conveying a simple set of signals to the locomotive drivers.

It is estimated that signals could be made at the rate of about 2 to 5 words per minute using either the flag system of the Duke of York or the semaphore device of the Chappé brothers, and since a code was used with both of these devices any desired message could be transmitted. But they, in common with all the other schemes of the pre-electrical era, depended upon good weather conditions, or good visibility for their successful operation and the distance over which signals could be sent was limited to the distance the human eye, aided by a telescope, could see, unless relaying was resorted to, which materially reduces the speed at which a message can be transmitted.

About 1729 a discovery relative to electricity, was made which diverted the efforts of scientists from the development of mechanical or visual telegraph systems to telegraph systems making use of the force electricity. The first electric telegraph system was proposed in 1753. This system which will be described later was impractical and, records indicate, was never tried out. The first practical electric telegraph scheme was proposed about 1820. You will note that even at the time the Chappé brothers were introducing their visual system, the development work on the electric telegraph was taking place.

**Stephen Gray**

The progress of the development of the electric telegraph hinged upon a number of discoveries. In 1729, Stephen Gray discovered that the influence of electricity could be conveyed

Fig. 3. Panels for carrier system.

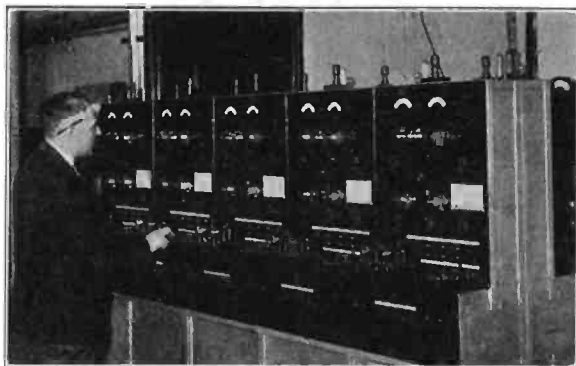

to a distant point by means of an insulated wire. Between 1767 and 1800 scientists including Galvani and Volta discovered the phenomenon connected with the voltaic pile and constructed this device for providing a sustained source of electrical energy. In 1805 Romagnesi discovered that a wire carrying an electric current is capable of deflecting a magnetic needle. In 1820 Schweigger discovered that if a coil of several turns of wire carrying a current is placed around the magnetic needle the deflecting force is increased. In 1825 Sturgeon discovered that a bar of soft iron was rendered temporarily magnetic if surrounded by a coil of wire through which an electric current was passing. About 1830 Joseph Henry worked out the design for electromagnets suitable for responding to currents received over telegraph lines and about 1833 Gauss and Weber discovered that they could transmit telegraph signals over a line making use of induced currents produced by the motion of a coil of wire surrounding a bar magnet. These are probably the fundamental discoveries upon which our present electrical communication is based.

At the time of Stephen Gray's discovery, static electricity, together with the means of generating it and of detecting

its presence was known. The generating device was the electrophorus and the detecting device was the electroscopes. It was perfectly natural, therefore, that the first proposal for an electric telegraph should make use of such electricity for the operating energy and of the electroscopes for the indicating instrument. The proposal was made by Charles Morrison of Renfrew, Scotland, in 1753. Morrison's scheme made use of one line wire for each character to be transmitted, 26 wires in all, the transmitting operator electrifying the wire associated with a particular character and the receiving operator knowing the character being sent by the response of a particular electroscopes. It is estimated that messages could be transmitted over this system at the rate of about 6 words per minute, which is a speed of about 2/10 words per minute per wire.

Morrison's scheme was followed by a series of similar schemes proposed by other scientists. These schemes made use either of the electrophorus and the electroscopes, or, later, when the devices became available, of the voltaic pile and the galvanoscope or galvanometer and still later of the dynamo electric machine and the electromagnet. Many of these schemes were quite interesting and some of them involved rather novel features. Time will not permit of a complete description, but I will point out the important features of some of these proposed schemes.

**Ronalds' Dial Telegraph**

In 1816, Ronalds proposed a scheme making use of a dial at each of the two stations, the dials rotating in synchronism and exposing to view, one at a time, a list of characters required for the transmission of a message. The dials were rotated once a second but other limitations of the system held the transmission speed down to the rate of about 5 words a minute, which however, was over one line wire. This was the first scheme proposed making use of the synchronous operation of units at the

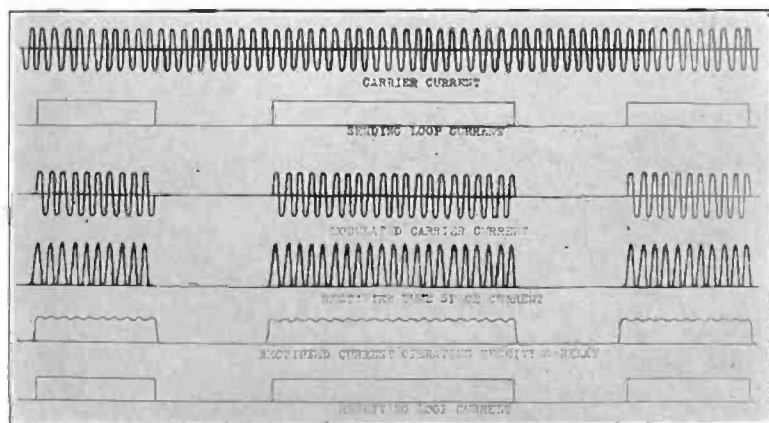

Fig. 2. Type B carrier telegraph. Modulation and demodulation.

Two stati  
posed a s  
Morrison  
letter of  
of the the  
galvanosc  
Ampere's  
transmit  
number o  
to be tran  
manner a  
of the ke  
top equip  
better M  
about 10  
system.  
the 26 w  
was only  
per wire.  
In 183  
graph sel  
and impr  
shilling  
tele pile  
gle line  
equipped  
the recei  
filled by  
feature c  
made use  
rent flow  
than in  
form the  
available  
pages we  
tem at  
words p  
one line  
a step fo  
are empl  
high spe  
Henry w  
tromagn  
ary of a  
undoubt  
ting up  
an elect  
Henry's  
like a p  
literally  
rected t  
laborato



the generat-  
phorus and  
the electro-  
magnetic, there-  
for an elec-  
use of such  
energy and  
indicating  
as made by  
frew, Scot-  
scheme made  
each char-  
wires in all,  
electrifying  
a particular  
ing operator  
sent by the  
electroscope.  
es could be  
at the rate  
te, which is  
s per minute

ollowed by a  
proposed by  
emes made  
rus and the  
the devices  
taic pile and  
ometer and  
electric mat-  
c. Many of  
resting and  
rather novel  
permit of a  
I will point  
of some of

graph

ed a scheme  
h of the two  
in synchron-  
one at a time,  
ed for the

The dials  
nd but other  
ld the trans-  
rate of about  
however, was  
was the first  
use of the  
units at the

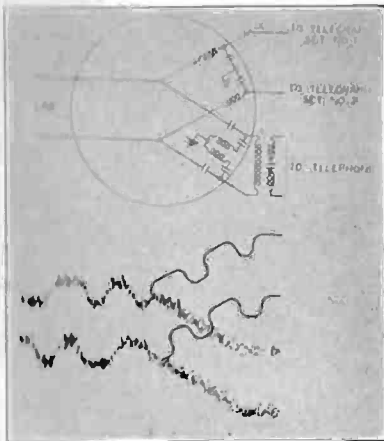

Fig. 4. Composite set.

two stations. In 1820, Ampere pro-  
posed a system quite similar to that of  
Morrison's, requiring one wire for each  
letter of the alphabet, but making use  
of the then available voltaic pile and the  
galvanoscope. The notable feature of  
Ampere's scheme was the use of a  
transmitting keyboard, consisting of a  
number of keys, one for each character  
to be transmitted, arranged in the same  
manner as the keys on a piano. Because  
of the keyboard and the faster operat-  
ing equipment used, Ampere was able to  
handle Morrison's speed and to handle  
about 10 words per minute over his  
system. However, since Ampere used  
the 26 wires, the speed of transmission  
was only about 4/10 words per minute  
per wire.

In 1832, Schilling proposed a tele-  
graph scheme which with modifications  
and improvements is still in use today.  
Schilling's scheme made use of the vol-  
taic pile and the galvanoscope. A sin-  
gle line wire was proposed and was  
equipped with a single galvanoscope at  
the receiving end. Signals were han-  
dled by means of a code and the novel  
feature of Schilling's system is that it  
made use of current reversals, the cur-  
rent flowing first in one direction and  
then in the other over the line wire to  
form the signals. With the codes then  
available it is doubtful whether mes-  
sages were handled over Schilling's sys-  
tem at speeds greater than about 10  
words per minute, but this was over  
one line wire and was, therefore, quite  
a step forward. Such polarized signals  
are employed in most of our present-day  
high speed telegraph systems. In 1831,  
Henry was able to construct some elec-  
tromagnets, based on Sturgeon's discov-  
ery of a few years previous, and to him  
undoubtedly belongs the credit for set-  
ting up the first system making use of  
an electro magnetic receiving device.  
Henry's telegraph receiver looked much  
like a present-day single acting bell and  
literally rang out the signals when con-  
nected to the end of a relatively long  
laboratory line.

Morse's Invention

In 1837, Morse patented a form of  
self-recording, electromagnetic tele-  
graph and because of the publicity his  
invention received he became known as  
the "Father" of the telegraph. Morse's  
original transmitter consisted of a set  
of blocks bearing various numbers of  
projections on one surface and a con-  
tact making device through which the  
blocks were passed to open and close  
the circuit. His original recording re-  
ceiver consisted of a pendulum, bearing  
a pen at the lower end, and so sus-  
pended with relation to an electromag-  
net that when the magnet was energized  
the pendulum moved. A strip of paper  
was passed under the pen by means of  
a clockwork mechanism and the strokes  
of the pen recorded the signals on the  
paper as the pendulum moved. Morse  
proposed the use of a numbered vocabu-  
lary in connection with his instruments  
to serve in interpreting the signals re-  
corded on the tape.

To assist with the work of patenting  
his invention, Morse entered into an  
agreement with Alfred Vail and two  
others by which they were to share the  
expense and labor and likewise the re-  
turns on the invention. Vail took hold  
of the telegraph and in short order so  
improved Morse's instruments that they  
are still in use today for the manual  
transmission of the Morse code with  
only minor changes and refinements in  
design. Vail was also responsible for  
the improved code known as the Ameri-  
can Morse code. With this code and  
the telegraph system set up by Morse  
and Vail, it is probable that good op-  
erators could handle messages at the  
rate of 20 to 25 words per minute using  
a single line wire. Subsequent improve-  
ments have increased this speed to ap-  
proximately 35 words per minute.

In England, Schilling's telegraph sys-  
tem was later improved by Cooke and  
Wheatstone and became the standard  
telegraph system of the Continent. A  
somewhat different code was used with  
it, the Continental code, and it is capa-  
ble of transmitting messages at the rate  
of approximately 20 to 30 words per  
minute.

Early in his experience with trans-

mission over a line circuit, Morse dis-  
covered that satisfactory transmission  
could be obtained only over lines of  
limited length and that if a longer cir-  
cuit was to be worked some means of  
repeating signals from one section of  
the line to another had to be devised.  
Such a repeater, today known as the  
single line repeater, was first used by  
Morse in 1838. This was a crude de-  
vice and required the attention of an  
operator whose duty it was to throw  
a switch which reversed the direction  
of the repeater and permitted the re-  
ceiving operator to talk back to the  
sending operator. This mechanical  
switch was not eliminated until about  
1855 when a scheme of relays was  
worked out, which permitted transmis-  
sion of telegraph signals in either direc-  
tion through one of these repeaters.  
This repeater is important mainly be-  
cause it eliminates the manual relaying  
of messages at the end of each section  
of line. Manual relaying seriously de-  
lays the transmission of a message,  
multiplying the time required for the  
initial transmission by the number of  
line sections, or, to provide a concrete  
example, effectively reducing the rate  
of transmission from 25 to 8 words per  
minute on a message handled at two  
relay points.

Duplex Telegraphy

A very important step in telegraphy  
was the employment of one line wire  
to convey more than one message at a  
time. A solution of the problem of  
transmitting two messages simultane-  
ously, one in each direction, was at-  
tempted by Dr. Wm. Gintl, of Vienna, in  
1853, and later by several others. None  
of the methods proposed were satisfac-  
tory because they all left out of account  
the electrostatic capacity of the line. It  
remained for J. B. Stearns, of Boston,  
to take this feature into account and  
arrive at the correct solution, in 1871.  
The balancing scheme used by Stearns  
to take care of the line capacity is  
still used today on land line telegraph  
circuits. The duplex set effectively  
doubles the speed of transmission of a  
circuit since it permits the simul-  
taneous transmission of two messages.

Fig. 5. Type B carrier telegraph. Terminal connections.

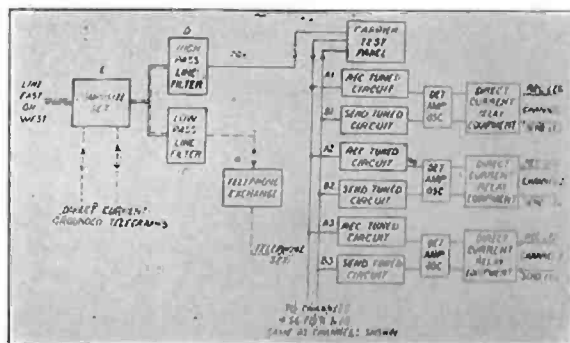

### The Quadruplex

Next the problem of sending two messages in each direction was worked out. This involves the simultaneous transmission of two messages in the same direction. Dr. Gintl also tackled this problem, in 1853, but without marked success. The first successful method was worked out by Edison in 1874 and his method, with some modifications, is still used. In 1876, Gerrit Smith of the Western Union Telegraph Company invented a system and his scheme became known as the Western Union standard quadruplex. The quadruplex effectively multiplies the transmission speed over the line by four since it permits the simultaneous transmission of four messages, two in each direction.

Quadruplex systems, however, have faults and are noted for their erratic action in times of bad weather. This fact, together with an urge for still greater speed of handling messages over the telegraph lines led experimenters to work along the lines proposed by Moses G. Farmer, of Salem, Mass., in 1852. Farmer's scheme made use of a commutator arrangement which connected the line circuit successively to a number of local circuits and later became known as a multiplex. A similar and much improved scheme was proposed by P. B. Delany, in America, about 1888. Delany's scheme, making use of brushes rotating synchronously over the faces of commutators at each of the two ends of the line, permitted as many as six operators to transmit messages simultaneously in each direction. If each of these operators worked at a speed of 30 words per minute the system was capable of transmitting 180 words per minute in each direction, or a total of 360 words per minute over a single wire. To attain this speed, however, 24 operators experienced in the Morse code were required, 6 sending and 6 receiving at each end of the circuit.

### Printing Telegraphs

Sometime after Morse patented his telegraph, a different type of telegraph system was brought out which per-

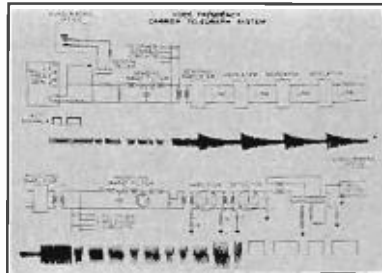

Fig. 7. Voice frequency telegraph system.

mitted an operator to type the message on a keyboard and provided for the reception of the message at the other end by actually printing or typing it out on a tape or a sheet of paper. These systems were known as printing telegraph systems because of the particular method of recording the message at the receiving end of the circuit. The first of these printing telegraphs was patented in 1846 by Royal E. House of Vermont. This system was first introduced commercially between New York and Philadelphia in March 1849, and could handle messages at the rate of about 43 words per minute. This speed was obtained over a single line wire, but transmission was effected in only one direction. A number of other printing telegraphs were brought forth, all similar to that of House, but in 1875 Phelps introduced an innovation in printing telegraph schemes which consisted of the inclusion of an electric motor in the printer itself to operate printing mechanism. This electric motor replaced clockwork mechanisms of earlier models and our most modern present-day printing telegraphs make use of a similar electric motor for the operation of the printer mechanism.

### Multiplex Telegraphs

In 1900 a Frenchman, Baudot, brought out what was termed a multiplex printing telegraph system. Baudot's scheme made use of the printing telegraph, of the multiplex proposed by Farmer and of the duplex, thereby permitting the simultaneous operation of

six printers in each direction over a common line wire. The printer itself differed little from other models, but the keyboard was a simple affair making use of only a few keys and requiring the knowledge of a code on the part of the transmitting operator. The printers were capable of operating at a speed of 30 words per minute and at this speed a total of 360 words per minute could be handled over this system. The Baudot system was little improvement over the Delany system as both required operators having the knowledge of their respective codes.

Baudot's system was really the forerunner of our present-day high speed multiplex telegraph systems, which however, as used in the plant of the Canadian National Telegraphs makes use of somewhat different equipment. Our multiplex system may be said to be based on the multiplex introduced in 1888 by Delany and consists of a four channel multiplex circuit operated in conjunction with 8 start-stop Morkrum printers, 4 working in each direction. The Morkrum printer is one of the more modern of the printing telegraphs. Approximately 50 words per minute can be handled over each printer circuit and this provides a transmission speed of 200 words per minute in each direction or 400 words per minute for the system and does not require operators trained in the Morse or Baudot code.

### Carrier Current Telegraphs

We have discussed the various development phases of the electromagnetic telegraph and have endeavored to describe some of the modern, high speed forms of the telegraph. The telegraph equipment so far described is known as direct-current equipment because of the fact that it makes use of direct-current line signals. In addition to the hand speed Morse circuits and the high speed printer and multiplex circuits, we have in the plant of the Canadian National Telegraphs several types of carrier telegraph systems.

The carrier telegraph system is a result of discoveries made about 1886 by Elisha Gray, Bell, Edison and others. A simple experiment in physics consists of the setting up of three tuning-forks a short distance apart on a table or bench. Two of these tuning-forks are adjusted to exactly the same frequency. We will call these forks A and B. The third tuning-fork, C, is of some different frequency, not a harmonic of the frequency of forks A and B. Now if fork A is made to vibrate, in a few seconds fork B will of its own accord start vibrating in response to the impulses received through the air from fork A. Fork C being of a different frequency remains in a non-

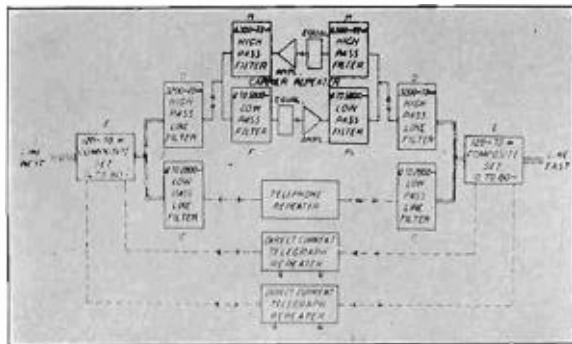

Fig. 6. Type B carrier telegraph. Repeater connections.



tion over a printer itself models, but the affair makes and requires code on the operator. The operating at a minute and at 10 words per over this system was little delay system's having the active codes. Usually the fore- high speed items, which plant of the graphs makes nter equipment. It is said to ex introduced l consists of plex circuit th 8 start-stop working in rkrum printer modern of roximately 50 handled over this provides 200 words per and does not in the Morse

## Telegraphs

the various the electromag- e endeavored modern, high egraph. The or described is equipment be- makes use of . In addition e circuits and and multiplex plant of the graphs several systems.

system is a re- about 1886 by n and others. physics consists e tuning-forks on a table or ning-forks are me frequency. es A and B. 2, is of same a harmonic of and B. Now vibrate, in a ll of its own n response to rough the air C being of a ins in a non-

vibrating condition. Gray used in his harmonic telegraph, the first carrier telegraph system, this principle of sympathetic vibration of tuned reeds or forks. At the transmitting end of his system he set up three vibrating forks each equipped with a contact to open and close a circuit carrying an electric current. Electric currents interrupted at the three different frequencies of these tuning-forks were transmitted over the line to the receiving end where the signal impulses were made to operate on similar tuning-forks or tuned reeds through electro magnets. Obviously the receiving fork in any particular channel would respond only to impulses from its particular sending fork at the distant end and telegraph signals impressed on the carrier currents generated by the tuning-forks could thus be transmitted over a line circuit. Tuned reeds were used at the receiving end in place of tuning-forks because of the more rapid response of the reeds. Even with the reeds, however, this system was sluggish and signaling was at a low rate of speed.

About 1892 several investigators, Pupin, Hutin and Leblanc, and John Stone independently invented about the same time the electrical method of selection of carrier frequencies. These investigators conceived the idea of using tuned circuits, including capacity and inductance, providing two tuned circuits for each channel, one at the transmitting end and one at the receiving end. The tuned circuit at the transmitting end prevented the transmission of all frequencies, except the channel frequency, to the line and the one at the receiving end prevented the reception of all frequencies, except the channel frequency by the channel receiving circuit.

In 1894, John Stone, at that time with the American Telephone and Telegraph Company, started development work which, with later contributions made by others, resulted in the installation in 1917 of a four channel experimental carrier telegraph system. This experimental system was operated between Chicago, Ill., and Maumee, Ohio. Two years later, in 1919, the first commercial carrier telegraph system was placed in service, a 10 channel system, between Pittsburgh and Chicago.

Major General G. O. Squier, of the United States Signal Corps, in 1910, carried on experiments with carrier currents. Using high frequencies or frequencies in the radio range and using largely radio equipment he successfully operated carrier systems over relatively short telephone lines.

Since the installation of the first commercial carrier telegraph system by the American Telephone and Telegraph Company in 1919 a considerable amount of development work has been done

with the result that today there are several types of highly efficient carrier telegraph systems available for use.

In the plant of the Canadian National Telegraphs there are two types of carrier telegraph systems, one a 10 channel system and the other a 12 channel system. The 10 channel system makes use of alternating currents of frequencies ranging from 3,000 to 10,000 cycles and provides 10 two-way telegraph channels over one pair of line wires. The second or 12 channel system, makes use of alternating currents in the range 400 to 2,300 cycles. This system requires for its operation two pairs of line wires and on these two pairs of wires provides 12 two-way telegraph channels.

You will observe that one of these systems makes use of very much higher frequencies than does the other. The alternating currents, or carrier currents as we call them, used on the line wires are quite small and require for their successful transmission specially constructed line circuits. The requirements in connection with line facilities for use with carrier telegraph systems become more severe as higher carrier frequencies are used. The line requirements of the 10 channel system, therefore, are much more severe because of the high frequencies used than are the line requirements of the 12 channel system and for this reason we can afford to use the two line circuit to obtain the equivalent of 6 two-way channels per line pair with the lower frequency carrier currents.

The Canadian National Telegraphs is now installing and expects to place into operation shortly a third type of

carrier telegraph system using still higher carrier frequencies than does the 10 channel system and this system is expected to provide 24 two-way telegraph channels on one pair of line wires.

## Combined Telegraph and Telephone

A feature of these carrier systems not previously mentioned is that their operation on the line wires does not prevent the use of these same line wires for other services. We are now obtaining a voice telephone circuit and two direct-current telegraph circuits of the simple Morse type from the same pair of line wires that is used to handle the carrier currents of the 10 channel system. The same additional communication facilities will be obtainable from the pair of line wires used in connection with our 24 channel system. Because of the carrier frequencies used by the 12 channel system, a telephone circuit cannot be operated over the same line wires, but one direct-current telegraph circuit can be operated over each line wire making a total of 12 two-way carrier telegraph channels and 4 two-way direct-current telegraph channels obtainable from the 4 line wires.

The carrier telegraph systems provide a transmission circuit for telegraph signals equivalent to that provided by a high grade copper wire circuit. Each one of the telegraph channels is, therefore, capable of handling the signals of one of the high speed automatic telegraph systems and we are working today four-channel

Fig. 8. Equipment for one terminal of 24-channel system.



multiplexes operating at overall speeds of 400 words per minute on many of the carrier telegraph channels. Now, if we equip each of the two line wires of a pair with a four-channel multiplex, the total signal speed obtainable over the pair would be 800 words per minute. On the other hand, if we equip this pair with a 10 channel carrier system we can operate the line wires themselves to obtain a transmission rate of 120 words per minute and by operating a four-channel multiplex on each carrier channel we can obtain a total of 4,000 words per minute over the carrier system, which makes a total of 4,120 words per minute for the pair of line wires or 2,060 words per minute per wire. This appears to me to be quite an appreciable increase in transmission speed over the five words per minute possible with the flag signals or the Chappé semaphore described in the first part of this paper. The use of the 24 channel carrier telegraph system will provide an even greater speed. No one knows when we will cease our endeavour to obtain still higher speeds of communication, but you may rest assured that we have by no means reached the limit, and the near future will see further improvements in telegraph service making for still greater speed in handling messages.

These amazing increases in the speed of handling telegraph messages, brought about by the use of the carrier telegraph, may make one wonder, perhaps, as to just what this carrier telegraph is. We have already indicated in describing the experiments of Elisha Gray, the general idea upon which the carrier system is based.

The 10 channel carrier telegraph system referred to previously is known as the Type B, or high frequency, carrier telegraph system. It consists of 10 individual transmitting and 10 individual receiving circuits at each end of the line and for the transmission of signals over the 10 two-way channels

twenty different carrier frequencies are provided. The use of twenty frequencies is necessary in order to permit of the separation by means of tuned circuits of the frequencies used by the 2 one-way carrier circuits making up a single carrier channel. The elements of one terminal of a single carrier channel are shown in Fig. 1. We see from this figure that the subscriber is provided with two loops. One of these, the sending loop, contains a telegraph key and a sounder, and the other, the receiving loop, contains only a sounder. We note that when the subscriber operates the telegraph key in his sending loop a relay connected in the loop is actuated by the loop signals. The contacts of this relay are connected in series with a modulating circuit bridged across the input of an amplifier tube. A vacuum tube oscillator adjusted to work at the carrier frequency of the particular channel supplies carrier current through a gain control device to this same amplifier tube. The operation of the modulating circuit serves to open and close what is in effect a short circuit across the input of the amplifier and in so doing either permits carrier current to flow through the amplifier to the line circuit or reduces the carrier current reaching the line circuit through the amplifier approximately to zero. The modulating device, following the signals made with the telegraph key by the subscriber, transmits to the line long and short impulses of carrier current to correspond with the signals made with the telegraph key. This modulated carrier current is transmitted through a sending tuned circuit and through a line transformer to the line. The other nine transmitting circuits of a terminal are connected in parallel with this transmitting circuit to the sending winding of the line transformer.

Carrier currents being received from the distant end pass from the line through the line transformer to the 10

receiving circuits of the terminal connected in parallel with each other. Each receiving circuit is provided with a tuned circuit which permits of the passage through its networks of the carrier frequency to which it is tuned, but offers resistance to the passage through its networks of carrier currents of all other channel frequencies. The receiving tuned circuit functions, therefore, to select the carrier current of a particular channel. This channel carrier current, having been separated from the nine other channel carrier currents on the line, passes through a two stage vacuum tube amplifier provided with a gain control. From the amplifier the incoming carrier signals are passed to the rectifier or detector tube in which they are changed from alternating to direct-current signals such as can be used to operate a relay. The rectified carrier signals are of a low current value, a value of the order of 5 milliamperes, and this small current is used to operate a receiving relay which in turn repeats much stronger direct-current telegraph signals to the receiving loop where they operate the sounder in the subscriber's office. The current in the receiving loop is of the order of 60 milliamperes.

A carrier telegraph channel provided with two loops as shown in Fig. 1 is known as a full duplex channel and permits of the simultaneous transmission of a message in each direction. Means are provided in the direct-current telegraph circuits of each carrier panel for so connecting the sending and receiving relays together, that the receiving loop to the subscriber's office may be dispensed with and signals both transmitted and received over one loop. Such a circuit arrangement provides a half duplex channel and provides for the transmission of only one message or for the transmission in only one direction at a time. Certain classes of telegraph service make such a connection desirable.

#### Modulation and Demodulation

We have discussed briefly the operation involved in modulation and demodulation in a carrier telegraph channel. Reference to Fig. 2 will perhaps make this explanation somewhat clearer, for this figure shows the direct-current signals made in the transmitting loop by the operation of the telegraph key, shows the unmodulated output of the oscillator and shows the carrier current, modulated by the direct-current sending loop signals, as transmitted to the line.

Similar modulated carrier signals arrive with usually small changes in the envelope at the receiving terminal and are selected by means of a particular receiving tuned circuit, amplified to a value governed by the gain control

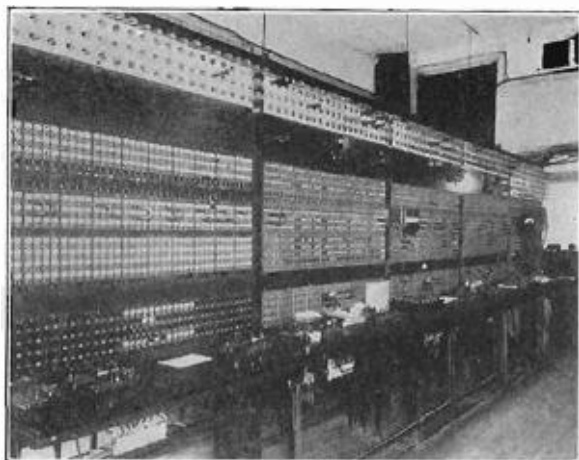

Fig. 9. Telegraph switchboard in Montreal office, Canadian National Telegraphs.

terminal con-  
each other.  
provided with  
limits of the  
works of the  
n it is tuned,  
the passage  
carrier currents  
encies. The  
ctions, there-  
current of a  
channel car-  
annel carrier  
es through a  
mplifier pro-  
l. From the  
carrier signals  
r or detector  
hanged from  
rent signals  
erate a relay.  
als are of a  
e of the order  
is small cur-  
ceiving relay  
uch stronger  
signals to the  
y operate the  
s office. The  
loop is of the

annel provided  
in Fig. 1 is  
channel and  
ous transmis-  
each direction.  
the direct-cur-  
each carrier  
the sending  
ether, that the  
scriber's office  
d signals both  
over one loop.  
ent provides a  
provides for  
one message  
in only one  
tain classes of  
uch a connec-

### Modulation

efy the opera-  
tion and de-  
rier telegraph  
ig. 2 will per-  
tion somewhat  
ows the direct-  
the transmitt-  
on of the tele-  
unmodulated  
and shows the  
d by the direct-  
als, as trans-

carrier signals  
all changes in  
iving terminal  
s of a particu-  
it, amplified to  
e gain control

device and applied to the grid of the rectifier tube. Fig. 2 shows the pulsating current derived from the rectifier and shows the rectified current signals reaching the sensitive receiving relay after passing through an elementary filter connected between the rectifier and the relay. The figure also shows the signals repeated into the receiving loop. You will note, by comparison, that the signals made in the sending loop appear to be received without change in the receiving loop at the distant end of the circuit. Unfortunately this is a very rare occurrence owing to the fact that the wave shape of the direct current signals is affected by the inductance of relays and other pieces of equipment connected into either of the loops and owing to the fact that the envelope of the modulated carrier signal undergoes changes in its transmission over the line circuit due to the characteristics of the line and to the presence of various filter networks in the line circuit. An accelerating or bias correcting device is, however, provided in each receiving circuit of the channel which, functioning in conjunction with the rectified current signals, tends to counter-balance somewhat the effect of the sending loop and the line circuit on the signals.

Figure 3 shows operating panels installed at Montreal.

### Filter Networks

As indicated, other services besides a carrier telegraph system can be operated over the same pair of line wires. This is so, providing the various types of service lie in different ranges in the frequency spectrum. When such is the case these various services can be separated at terminals and at repeater points by the use of filter networks. If, for instance, we are to operate two direct-current telegraph circuits, one on each line wire, at the same time that we are operating the carrier, a composite set is required at each point where it becomes necessary to separate the line currents of the two kinds of telegraph. The composite set is shown in Fig. 4. In this figure, we have endeavoured to show graphically the manner in which the two kinds of signals are separated, the direct-current signals passing through one branch, the low-pass side of the composite set, and the higher frequency or alternating-current signals passing through the other branch or high-pass side of the composite. Similarly, if on the same line with the carrier and the d.c. telegraph we are to operate a voice telephone circuit, the voice currents are separated from the carrier currents by means of what may be termed high frequency com-

posite sets. Such a composite set will consist of two filters, a high-pass and a low-pass filter connected in parallel either to the line, when no d.c. telegraph is being used, or to the high-pass side of the composite set when this set is installed. The use of such a high frequency composite set is shown in Fig. 5.

### Line Circuits

As indicated, carrier telegraph systems require somewhat special line circuits. The every-day d.c. telegraph circuit makes use of a single line wire and uses the ground for a return path. The line currents used by the carrier telegraph system are of a very low value and if an attempt was made to operate a carrier system on a ground return circuit the interference reaching the carrier receiving circuits would be such as to prevent the operation of the system. It is necessary, therefore, to provide a metallic circuit or a pair of wires on which to operate a carrier current system and it is further necessary to transpose or interchange at intervals the positions of the two line wires with respect to the other wires on the same pole line. This transposing is done merely by shifting the line wire from one pin position to that of its mate at the same time shifting the mate to the pin position of the first wire. This transposing so arranges the two wires of the pair that interfering currents picked up along any one section or sections tend to neutralize themselves so far as the terminal equipment of the circuit is concerned. The higher the frequencies used by a carrier system, the more frequently must these transpositions be made to secure satisfactory operation and freedom from cross-talk and foreign interfering currents.

Because the line currents used by a carrier system are very small in value and because there is a practical limit to the sensitivity that may be built into a carrier receiving circuit, the length of line over which carrier transmission can be effected between two terminals is limited, unless we install some intermediate means of amplifying or reinforcing the line currents. In connection with the ten channel carrier telegraph system, use is made of vacuum tube amplifiers spaced at distances of between 150 and 300 miles along the line to extend the range of the system and by the use of such amplifiers we are able to operate a system with the terminals approximately 1,200 miles apart. This is not the maximum operating limit, but happens to be the longest distance between terminals of any carrier system in the plant of the Canadian National Telegraphs.

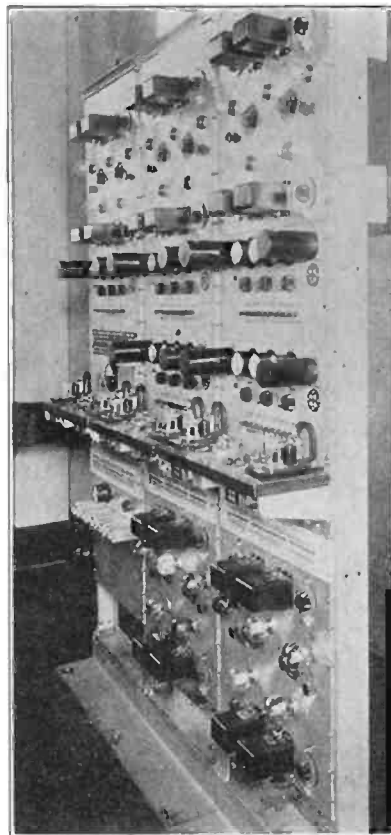

Fig. 10. Terminal equipment for five two-way telegraph channels.

### Repeaters

We have not as yet found repeaters which will amplify all frequencies in the range, zero to 10,000 cycles and for this reason it becomes necessary at each one of the repeater points to separate the line currents of the various types of systems operating on a pair of wires. This is done by means of composite sets and high frequency composite sets, as it was at the terminals, and once the various line currents are separated, those for each kind of communication service are amplified or repeated by means of equipment especially suited to the particular line currents. I have told you that the ten channel carrier telegraph system makes use of twenty different carrier current frequencies, ten of these being used in each direction. In order to provide a two-way repeater for the carrier current some means of separating the carrier currents traveling in the two directions must be devised. Filters are used for this purpose; a group or pair of what are termed directional filters, one a high-pass and the other a low-pass. A pair of these directional filters is connected to each side of the carrier amplifier equipment and these filters separate the two groups of carrier

currents traveling in opposite directions permitting the amplification of the group traveling in each direction by means of a separate amplifier. The connections at such a repeater point are shown in Fig. 6 for a repeater station at which direct-current telegraph signals and voice telephone line currents, as well as the carrier currents, are amplified. You will note that an equalizer is included ahead of each carrier amplifier in this figure. This is necessary because of the fact that while the frequency characteristic of the amplifier is practically flat the frequency characteristic of a section of line is not, and the equalizers are installed in an attempt to provide an equal transmission equivalent from terminal to terminal on a carrier telegraph system for all the carrier frequencies of either frequency group.

#### Voice Frequency Carrier Telegraph

In addition to the ten channel carrier telegraph system making use of a pair of line wires I have mentioned a 12 channel carrier telegraph system making use of a different portion of the frequency spectrum and requiring for its operation two pairs of line wires. This particular system was really designed for operation over long cable circuits where a quad or group of four wires is available for each telephone or carrier telegraph circuit. Because of the frequency characteristic of cables which does not permit of the transmission of high frequencies unless loading is resorted to, the frequencies of this system were kept as low as possible and are, therefore, in the voice range. Because a quad, or group of four wires, was available which would provide two distinct transmission circuits, one to be used in each direction, it was not neces-

sary to use different frequencies for transmission in the two directions. The system, therefore, makes use of the same frequencies in one direction as it does in the other. We have no very long cable circuits in the plant of the Canadian National Telegraphs, but because this system may be used on practically any open wire pairs suitable for telephone service and because it may readily be modulated onto the channels of any one of a number of types of carrier current systems, it is useful. Two systems are in operation over open wire lines and the 24 channel system to which I referred will make use of two of these 12 channel systems modulated onto the channels of still another carrier current system. Fig. 7 shows, in diagrammatic form, one complete transmission circuit of a 12 channel or voice frequency carrier telegraph system. The transmission circuit in the opposite direction makes use of identical equipment and of an identical line circuit. For convenience in operating, the sending and receiving equipment of each channel is assembled as a channel unit although, unless the channel is being operated as a half duplex circuit the transmission circuits of the 2 one-way circuits making up the channel are entirely separate. Fig. 8 shows the equipment for one terminal of the 24 channel system. The four left-hand bays in this figure hold the equipment for the high frequency carrier channels onto which the two 12 channel systems are modulated. The next three bays hold the battery supply and carrier current generating equipment for the 12 channel systems while the eight right-hand bays, two groups of three channel bays and one filter bay each, hold the terminal equipment for

the 12 channel systems. This installation is in our Toronto office.

Because of the fact that the voice frequency carrier telegraph system makes use of carrier frequencies in the voice range a telephone channel cannot be operated on the same conductors, but each of the pairs of line wires may be equipped with composite sets and the four line wires may be used for both direct-current and carrier telegraph purposes.

The description given and the figures shown thus far cover the carrier current and line equipment only. Power obtained from storage batteries is used to operate the carrier current equipment. In addition to the power, the operation of the carrier current and other telegraph systems requires the making of many different circuit connections between lines or subscribers loops and the telegraph equipment. This is done by means of patching cords at the office switchboard. Fig. 9 shows the switchboard installed in the Montreal office. It has a capacity of 120 main line wires.

Fig. 10 shows the terminal equipment of still another carrier current telegraph system recently installed in the plant of the Canadian National Telegraphs. It provides 5 two-way channels, uses frequencies in the range 5,400 to 12,800 cycles and can be used on circuits up to 450 miles in length. It is intended for short haul use on routes not requiring the facilities supplied by a 10 channel carrier system.

I have attempted to discuss briefly the historical background of the telegraph and have attempted to provide a picture of the present-day high speed direct-current and carrier current telegraph systems.



#### SYNCHRONIZATION OF BROADCASTING NEAR REALIZATION

THE Federal Radio Commission's approval of the plan evolved by the National Broadcasting Company, WTIC, Hartford, and WBAL, Baltimore, for synchronizing transmitters on the same wavelength was the signal to begin immediate construction of the necessary apparatus, according to C. W. Horn, general engineer for NBC.

"We hope to have synchronization on an operating basis within a few months," Mr. Horn announces. "Our experimental tests have proved definitely that the operation of two or more broadcast transmitters on a single wavelength is beyond the laboratory stage. Engineers from the RCA-Victor Company already have visited Hartford and Baltimore, have studied the

situation thoroughly, and compiled their specifications for the special equipment. Now, with federal approval granted, this working application of synchronization is only a matter of time."

According to the terms of the petition approved by the Commission, WTIC and WBAL will synchronize on alternate days with one of NBC's key stations in New York. WTIC will be linked with WEAf, and WBAL will coordinate its transmitter with WJZ.

This means that the stations when operating in synchronism, will use a single broadcast channel.

The immediate advantage of the synchronizing plan about to be placed in effect, Mr. Horn pointed out, is that it will afford WBAL and WTIC full-time broadcasting schedules in their re-

spective service areas. Hitherto the two stations have shared a wavelength, and one of them necessarily has remained silent every other day. When synchronization goes into effect, WBAL and WTIC will retain their joint wavelength, using it as formerly; but on alternate days, the "silent" station will remain on the air by synchronizing with its key station in New York.



#### BOOK REVIEW

**PRACTICAL RADIO REPAIRING HINTS.** By John F. Rider. Published by Radio Treatise Company, Inc., New York. 260 pages.

In this new book Mr. Rider has assembled a large amount of radio circuit information of real value to servicemen.



ns. This installa-  
o office.  
ct that the voice  
elegraph system  
requencies in the  
channel cannot  
e conductors, but  
ne wires may be  
ite sets and the  
e used for both  
arrier telegraph

n and the figure  
the carrier cur-  
nt only. Power  
batteries is used  
current equip-  
the power, the  
er current and  
s requires the  
it circuit connec-  
ubscribers loops  
ment. This is  
ing cords at the  
x. 9 shows the  
to the Montreal  
y of 120 main

inal equipment  
current tele-  
installed in the  
National Tele-  
-way channels,  
range 5,400 to  
e used on cir-  
length. It is  
use on routes  
supplied by  
em.

Discuss briefly  
l of the tele-  
ay high speed  
current tele-

Hitherto the  
wavelength,  
rily has re-  
day. When  
nto effect,  
retain their  
as formerly;  
"silent" sta-  
y synchron-  
New York.

PAIRING  
ider. Pub-  
Company,

er has as-  
radio circuit  
to service-

# Home Recording to the Fore

By A. C. LESCARBOURA

Mem. I.R.E. Mem. A.I.E.E.

**H**OME recording, with home broadcasting as a side line, will be widely featured in the 1931 radio merchandising activities.

As a built-in feature and as an accessory, it will bulk large in the coming season's sales. It is a natural evolution. The engineering has been fully consummated. It is a direct challenge to the further invasion of the midget set into the home, since it provides so much more entertainment as to make the saving of the former hardly worth while.

The two great criticisms heretofore attached against radio are thrown into the discard by home recording. It has been claimed that, unlike the phonograph, radio has not been selective in the sense of choosing definite programs. True, one might choose between stations, but the choice was relatively limited in contrast with that afforded by a fine record library. And it has likewise been said that, unlike the piano or violin, radio has afforded its owner no joy nor satisfaction of self-expression of creation in the program enjoyed, which has always been an important factor in home entertainment.

Home recording, of course, presupposes the inclusion of a modern electrical type phonograph, preferably as a built-in feature of the radio set. And this is reasonable, for the trend is more and more towards combination sets especially in meeting the competition of the midget radio sets. Home recording, therefore, by insisting on the phonograph feature, makes possible the repetitive enjoyment not only of usual records, but also of fine radio programs which have been recorded by the set itself. Also, home recording makes possible the recording of the voice, musical attainments, group singing,

dialogue or any other accomplishments of the family circle, serving much the same "remembrance" function as the family kodak album.

## Making Records in the Home

The home-recording feature is based on the simple principle of reversing the operation of the usual electromagnetic pickup. Instead of driving the pickup by the action of a stylus or needle following the contortions of the record groove, thereby generating the modulated current that eventually drives the

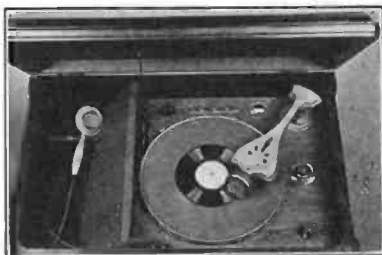

Built-in home recording feature on well-known combination console.

loudspeaker and reproduces recorded sounds, in home recording the electromagnetic pickup is fed amplified sound values either picked up by a microphone or by the radio receiver itself. Under the influence of the powerful input current, the electromagnetic pickup actuates a blunt point chromium plated recording needle which engraves the latent sound values in a special record. The metal records are pre-grooved, so that the cutting stylus follows the spiral groove and simply engraves the sides for the latent sounds.

Several radio sets have already



Accessory type of home recording equipment, using mechanical feed for tracking stylus.

appeared on the market with home recording as an integral feature. Inasmuch as such sets are offered for less than \$300 list, it becomes evident that this feature is not going to place complete radio-phonograph combinations in a prohibitive price class. The home recorder may be set either for the recording of home talent or for radio programs. In the former instance, the hand microphone is connected in circuit, a blank record placed on the turntable with cutting stylus held just over the beginning of the groove, after which the turntable is started. The pickup is weighted down with a special weight used only while recording. When proper turntable speed is attained, the stylus is lowered to the starting point on the record. The sounds to be recorded are then directed into the microphone until the end of the record is reached.

For recording broadcast programs, the desired program is tuned in to utmost clarity and the greatest possible undistorted volume. A blank record is placed on the turntable, and the turntable started. When it attains a steady speed, the pickup with special recording needle is lowered to the beginning of the record groove. The proper switch is operated so as to transfer the receiver output from the normal loudspeaker function to the recording circuit, although the program may usually be heard faintly during the recording. Thus the radio program is recorded.

## Home Made Records Universal

The home recordings may be played on any phonograph, either electrical or mechanical, in the usual manner, except that a special fibre needle is employed in place of the ordinary phonograph (Concluded on page 46)

**New Built-In Feature or Accessory Strikes Powerful Sales Note and Provides Radio Trade With Repeat Sales Item**

# R. M. A. Show

## THE R. M. A. Board of Directors and Show Committee have concluded arrangements with the Stevens Hotel, Chicago, for the 1931 R. M. A. Convention and Trade Show.

Plans and arrangements include the following items:

(1) Exhibition privileges in the Trade Show will be confined to R. M. A. members in good standing.

(2) Exhibiting members are required to show current radio merchandise or be denied the privilege of having either a booth in the exhibition halls or demonstration rooms.

Radio products only may be displayed in the exhibition halls.

Exhibiting members are permitted to exhibit radio products and products of their own manufacture other than radio products in demonstration rooms, provided such products are offered for distribution through the jobber and dealer channels represented by the Trade Show attendance.

(3) Exhibition space for the Trade Show will include the Stevens Hotel exhibition hall and in addition, the entire Grand ball room. These two locations are directly connected by a stairway, with total exhibition space available of about 30,000 square feet.

(4) Due to the irregularity of the size of the booths, all exhibit locations will be rented at a unit price per booth, which price is based upon approximately \$2.00 per square foot, and does not include furniture, carpets or fixtures.

(5) If eighty per cent or more of the total trade show space is sold and if in the opinion of the R. M. A. board of directors, the show income in excess of expense warrants such action, it is the intention of the Association to rebate proportionately to exhibitors the charge for space.

(6) The R. M. A. discourages lavish decoration in exhibition hall booths because these cause additional expense and competition which is distasteful to many exhibitors.

(7) Booth decorations constructed within the spirit of the previous paragraph may be installed by the exhibitor himself or upon an arrangement made directly with the convention and exhibit department of the Stevens Hotel, from which sketches and prices may be obtained upon application.

## A Radio Show That Deserves And Will Have Country-Wide Support

(8) Individual telephone booths will be provided by the convention and exhibit department of the Stevens Hotel upon an order with advance payment of \$10.00 attached. All telephone orders must be placed before June 1, 1931.

(9) Any construction or other incidental work of various trades required by exhibitors will be performed by the Stevens Hotel. Such orders also are to be placed in advance.

(10) Assignment of demonstration rooms in the Stevens Hotel, will be made by the show management. For the convenience of exhibitors and the trade it is desired that exhibitors establish their demonstration rooms in the Stevens Hotel, where the Association will assist in arranging for a-c. power and other facilities.

(11) Any exhibitor who reserves and maintains demonstration rooms in the hotels, other than the Stevens Hotel, will be required to make their own arrangements covering reservations and services required. The R. M. A. will not make reservations or arrangements in connection with demonstration rooms outside of the Stevens Hotel. Hotel demonstration rooms and all displays in hotel rooms of radio or other products are available only to members having booth exhibits in the trade show.

(12) Closed business meetings of the R. M. A. will be limited to two in number. The time will be announced at a later date. Failure on the part of any member who is exhibiting in the Trade Show to be represented at these two closed meetings, through either the delegate or alternate will result in forfeiture of \$50.00 deposit (paid with show space application) to the Association. No one will be admitted to the above meetings after the announced time of starting.

The Radio Show will continue from June 8 to 12, inclusive, 1931. Special trains will be run from various centers, and reduced fares will be in effect.

The show committee is planning upon an attendance of 25,000 persons during the week.

The facilities of this show will constitute a new opportunity for manufacturers of radio equipment to join the great movement toward prosperity.

## Entertainment

Although business rather than ballyhoo is the keynote of the Annual Convention and Trade Show of the Radio Manufacturers Association at Chicago next June, plenty of entertainment for the 25,000 visitors expected is being arranged under preliminary plans of the convention committee. This is headed by Leslie F. Muter of Chicago, chairman, and includes six other Chicagoans, all prominent in the radio industry: J. Clarke Coit, Henry C. Forster, A. S. Wells, E. N. Rauland, Thos. A. White and Harry Olson.

Prominent speakers are being secured for the several business sessions of the association and other radio meetings and plans being made for the proper reception of the industry throng.

For the radio week of June 8th at Chicago, Chairman Muter and his committee are also working on many entertainment features. An informal stag dinner with headline vaudeville talent is being planned instead of the usual formal banquet of the Radio Manufacturers Association.

## Advertising Managers Group

For discussion and action on radio advertising problems, the advertising interests of the RMA will be organized. The formation of an advertising group in the RMA, similar to the group organization of receiving set, tube and other manufacturers, for the consideration of their special problems, was authorized by the RMA board of directors. President Morris Metcalf of the RMA appointed as chairman of the new advertising group Paul S. Ellison of the Brunswick Radio Corporation of New York City.

## New RMA Directors

Two new directors, E. E. Shumaker, president of RCA-Victor Company of Camden, N. J., and Meade Brunet, sales manager of RCA Radiotron Company of Harrison, N. J., were elected to the RMA Board to fill vacancies caused by the resignations, respectively, of J. L. Ray, formerly vice-president and general sales manager of RCA-Victor Company, and G. K. Throckmorton, executive vice-president of E. T. Cunningham, Inc.

# Television for the Experimenter\*

By C. BRADNER BROWN

**T**HE status of amateur television at the present time is much the same as that of amateur radio 20 years ago. It is difficult to obtain apparatus at a reasonable price, and for this reason, the experimenter is generally forced to reconstruct material on hand. This paper presents some of the author's experiences and offers a few helpful hints to the prospective experimenter.

The first piece of apparatus necessary for a television set is a powerful short-wave receiving set. The usual short-wave set must be revamped for use as a television receiver as regeneration is one of the prime features in a short-wave receiver. Regeneration in the reception of television signals causes distortion and for this reason the regeneration equipment should be removed or a switch installed to uncouple it when used for television. An excellent set may be had by combining an autotune, screen-grid amplifier with the regulation screen-grid detector feeding into a resistance-coupled audio stage.

## The Amplifier

The next piece of apparatus to construct is an amplifier. At least three stages of resistance-coupled audio must be used. The audio system used by the author consists of three 227 type tubes in a resistance-coupled amplifier feeding into a 245 in the last stage. The filament circuit is arranged with a double-pole double-throw switch so that the filaments may be supplied with a-c. from a transformer or d-c. from a battery. The direct current gives better results but soon drains the supply battery, hence the other supply.

The actual television set consists of a disc driven by a small series, universal motor with the neon tube

mounted on top of the motor. The neon tube used is the small 110 volt model. The disc was constructed from a large size phonograph record having recording grooves on one side only. On the plain side, a spiral was laid out and divided into 60 radial divisions. A hole was bored where the radial lines meet the spiral. Several discs were constructed before one was secured in which the holes were of the proper size. The edges of the holes should overlap sufficiently so that the space covered by the holes in passing a certain spot appears to be uniformly covered. If the holes are too small, black lines will appear across the picture between holes. If the holes are too large, reproduction will be blurred. Since receiving conditions are none too good, many television sets fail at the very start through the use of a poorly constructed disc.

The driving motor used in these experiments is a small 1/50 h.p. series-universal. It is driven from the alternating-current mains using a 100-watt lamp in series with the motor. A 200-ohm rheostat across the armature gives good control of the speed. This system works very well except that "hunting" causes the setting of the rheostat to be shifted almost constantly. After experimenting with several intricate governors, the simple expedient of mounting

sible to obtain good results from mediocre equipment when the sending station is within 20 miles. It is a different matter, however, when the receiver is located from 500 to 1200 miles from the sending station.

It is necessary at the present time to select the station giving the best signal and construct the scanning disc to fit the requirements for reception from this station. This is due to the lack of uniformity in the sending equipment. Thus 48, 50, and 60 lines are variously used with 12, 16 and 20 frames a second.

The operation of the equipment is quite simple. The short-wave set is tuned in on the signal which is easily recognized by its characteristic buzz-saw tone and maximum volume obtained. The amplifier is started up with alternating-current, having the output switched over to the loudspeaker. When the signal is coming through at the maximum volume, the motor may be started up and the output turned into the neon tube.

The motor speed is set approximately with a speed counter and the small square in front of the neon tube watched carefully. The picture will generally appear quite blurred and will move onto the screen from one side. If an image is obtained, the filaments should be shifted to the direct-current supply. This can be accomplished by having a spring arranged to snap the switch from a-c. to d-c. when a catch is released. In general, this improves the reception greatly. The a-c. type heater tube was chosen because better results can be obtained. Operation with these tubes is much steadier.

Alternating-current disturbances generally appear as black bands moving in a vertical direction while static disturbances usually affect the entire image to produce distortion. Musical impulses show definite characteristics in a series of curving bands of black. It is interesting to experiment with musical impulses before trying to obtain images, as strong signals are easily obtained and the experimenter can learn much of the action of his equipment with these signals.

## VACUUM TUBES

**T**HE April issue of RADIO ENGINEERING will contain an up-to-the-minute review of the subject of Vacuum Tubes. Every engineer will want his own copy of this issue, as it will be in fact an April, 1931, book on vacuum tube engineering.

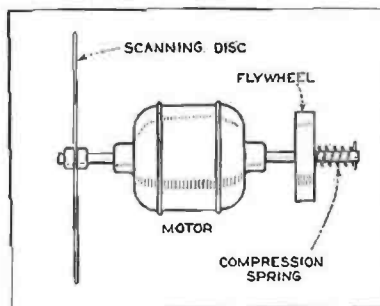

Fig. 1. Disc drive.

a heavy disc on the motor shaft was adopted. Since the scanning disc is mounted on the shaft, a double shafted motor was obtained and the flywheel mounted on the back end. The best results were obtained from the system shown in Fig. 1. In this system, the disc floats free on the shaft, being attached by the spring shown on the end of the shaft. This allows a slight movement with a ready storage of energy to correct for changes in the armature speed. A weight of about 5 pounds gives the best results.

It must be kept in mind that before any experiments can be carried out, a powerful and dependable signal must be had. Careful construction of the receiver and amplifier will eliminate 90 per cent of the trouble usually encountered in television sets. It is pos-

\* Paper presented before A. I. E. E. Branch, University of Kansas.

### MAGNETIC NICKEL ALLOYS

**M**AGNETIC alloys substantially free from carbon and comprising mainly iron and nickel are treated to produce high and constant permeability by heating to a high temperature, ex. 900° C. or over, until completely annealed followed after cooling by a further heating to a lower temperature not exceeding 700° C. but which is at least 50° in excess of the magnetic change point of the alloy and in the case of alloys containing not more than 50 per cent nickel preferably at least 100° above the change point. The alloy is preferably mechanically strained between the two heat treatments. Up to 10 per cent of one or more of the following elements may be added to increase the specific resistance of the alloy: manganese, chromium, copper, molybdenum, tungsten, vanadium, aluminum or silicon, and alloys containing specified proportions of nickel, iron and manganese; nickel, iron and chromium; and nickel, iron, and copper are referred to. In the manufacture of a loaded signaling conductor wire or tape made from a nickel-iron alloy may be annealed by heating at about 900° C. for 15 minutes, cooled, wound on a copper conductor, the winding producing the desired straining of the alloy, and the loaded conductor then heated for about 4 minutes at a temperature at least 50° above the change point and not exceeding 700° C. but preferably above 500° C. *Garnett, H. J. and Randall, W. F. British Patent 336,948. Appl. June 22, 1929. Issued: December 17, 1930.*

### HOME RECORDING TO THE FORE

(Concluded from page 43)

needle since the metal disc is necessarily softer than the usual commercial recordings. When playing back the record on the same machine on which it was recorded, the recording weight is removed from the pickup head.

The home recording accessory may be employed with any phonograph turntable and a radio amplifier of sufficient power. It comprises essentially a recording head actuated by the radio amplifier, a microphone and the necessary switching mechanism. In some designs a mechanical feed is employed to track the stylus in the groove, reducing the latter of this strain. An elaborate feed mechanism is attached to the shaft of the turntable.

Home recording is entirely practical. Several manufacturers are already merchandising combination sets with the home-recording feature, while an even greater number of manufacturers are on the market with home-recording accessories for use with any existing radio set and phonograph. It is the writer's

opinion that this season will see a number of combination sets on the market incorporating this feature, selling for \$115 to \$160 and placing the standard console once more on a pedestal with the midget sets shrinking into insignificance.

Meanwhile, the special metal discs are available to anyone. One organization is now licensing and selling these records to distributors of the various manufacturers of home recording equipment in four sizes, namely, 6-inch, 7½-inch, 10-inch and 12-inch listing at 20 cents, 30 cents, 50 cents and 75 cents respectively. The discs play on any phonograph with a fibre needle and will reproduce indefinitely.

### RCA LOSES APPEAL ON PATENT POOLING CASE

**T**HE United States Circuit Court of Appeals at Philadelphia, on Feb. 13, upheld the decision of the United States District Court of Delaware against the patent pooling agreements of four great electric, radio and telegraph and telephone companies.

The lower court had ruled that the "patent pooling" pacts of Radio Corporation of America and its associates violated the Clayton anti-trust law.

The Appellate courts action, which is considered of far-reaching importance in the radio industry, was rendered in a suit filed by the De Forest Radio Company and several independent tube manufacturing corporations. They claimed they were frozen out of the tube market by the patent pool, which, they said, was intended to give the Radio Corporation a monopoly over the sale of radio tubes to dealers and manufacturers to whom it sold its receiving sets.

Under the pooling agreements, it was claimed, licensees of the Radio Corporation were obliged to use in the receiving sets only the tubes which were manufactured by the Radio Corporation companies, thus virtually blocking De Forest and the other independents from selling their tubes to the Radio Corporation's licensees.

Judge Hugh M. Morris, who has resigned from the Delaware bench since he filed the decision, had ordered an injunction against the Radio Corporation, the only defendant in the suit, prohibiting it from continuing the pooling agreements and thus ending the alleged monopoly.

His first decision granting a preliminary injunction was carried to the Court of Appeals by the Radio Corporation several months ago, but the higher court upheld Judge Morris.

When on final hearing on the matter he granted a final injunction the Ap-

pellate Court again sustained him, and in the latest decision, written by Judge Buffington, senior member of the court, he said there were now two questions: first, whether the court should reverse its former decision, and, second, whether facts were developed on the final hearing before Judge Morris to indicate that while the pooling agreements may have been unlawful they did not have the effect of giving Radio Corporation a monopoly.

As to the first proposition, Judge Buffington said the higher court stood on its previous decision, and, as to the second, "we are of opinion, without here discussing the proofs made, that there is nothing in them which would lead us to the conclusion that the objectionable contract has not resulted in a monopoly.

With reference to this decision, the Radio Corporation of America made the following statement:

"We shall apply as promptly as possible to the Supreme Court of the United States for a writ of certiorari. The clause to which the litigations was directed, as a matter of fact, has not been in force since July, 1928. Nevertheless, the case raises important and novel questions as to the rights of an owner of patents in the granting of licenses. These questions have not yet been passed upon by the Supreme Court."

### MEMBERSHIP IN I. R. E.

**S**UBSCRIBERS to RADIO ENGINEERING, who desire to procure membership in the Institute of Radio Engineers, may obtain application forms by writing to Donald McNicol, Editor of RADIO ENGINEERING, 52 Vanderbilt Ave., New York

### ONLY 13 OUT OF 1,500,000 WATTS BROADCAST ARE USED

**T**HOUGH American broadcasting stations use an aggregate of nearly 1,500,000 watts of power, an engineering professor of Massachusetts Institute of Technology has estimated that the power received by the average receiving set's antenna amounts to the equivalent of the energy consumed by the common housefly walking a distance of one foot up a window pane.

Comes now an engineer of the Federal Radio Commission with a calculation showing that, with 13,500,000 radio receiving sets in use in the United States, their aggregate "consumption" of broadcasting power amounts to only 13.6 watts. All the rest of the broadcast energy is dissipated in space.

ed him, and  
en by Judge  
of the court,  
o questions:  
ould reverse  
nd, second,  
oped on the  
e Morris to  
oling agree-  
lawful they  
rying Radio

on, Judge  
court stood  
d, as to the  
on, without  
made, that  
which would  
that the ob-  
t resulted in

decision, the  
merica made

ply as pos-  
ourt of the  
of certiorari.  
gations was  
act, has not  
28. Never-  
important and  
ights of an  
granting of  
ave not yet  
e Supreme

R. E.  
ENGINEER-  
are member-  
o Engineers,  
ms by writ-  
Editor of  
derbilt Ave.,

000 WATTS  
USED

broadcasting  
e of nearly  
an engineer-  
etts Institute  
ed that the  
ge receiving  
e equivalent  
the common  
of one foot

of the Fed-  
h a calcula-  
00,000 radio  
the United  
consumption"  
unts to only  
the broad-  
space.

*Simplicity in design of  
1931 Radio Receivers  
is aided by this new...*  
**SPRAGUE**  
*Inverted Type  
Electrolytic*  
**CONDENSERS**

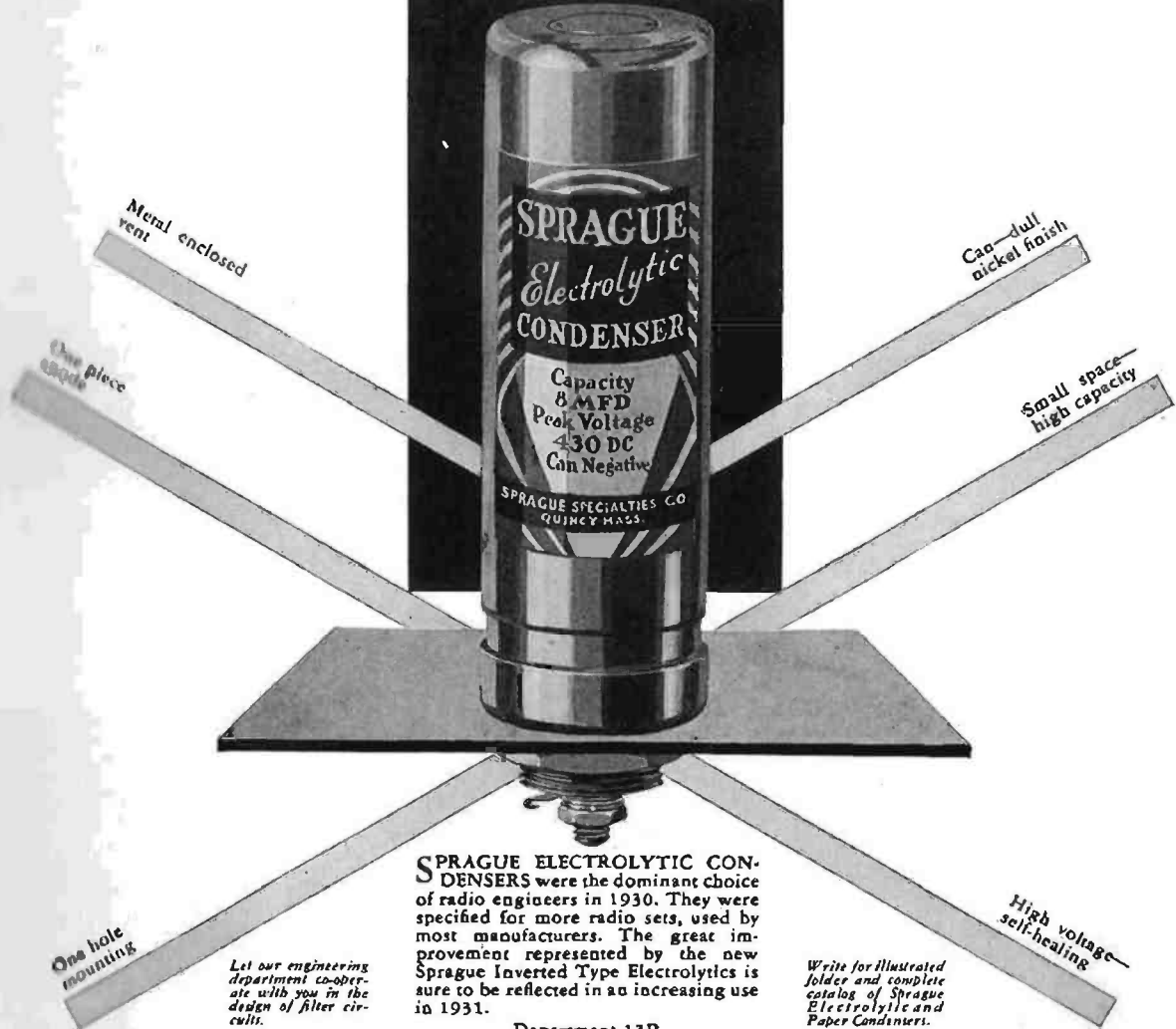

**SPRAGUE ELECTROLYTIC CONDENSERS** were the dominant choice of radio engineers in 1930. They were specified for more radio sets, used by most manufacturers. The great improvement represented by the new Sprague Inverted Type Electrolytics is sure to be reflected in an increasing use in 1931.

*Let our engineering department co-operate with you in the design of filter circuits.*

*Write for illustrated folder and complete catalog of Sprague Electrolytic and Paper Condensers.*

Department 13B  
**SPRAGUE SPECIALTIES COMPANY**  
North Adams, Mass.

**SPRAGUE**  
*Electrolytic* **CONDENSERS**



### R. H. MANSON PRESIDENT, INSTITUTE OF RADIO ENGINEERS

**R**AY H. MANSON, a member of the Board of Direction of the Institute of Radio Engineers (1928), and a member of the A. I. E. E. since 1902, has been chosen president of the Institute of Radio Engineers, taking office at the recent January meeting.

He was born at Bath, Maine, was graduated from the University of Maine in 1908, and received his degree of E. E. from that institution in 1921. From 1899 to 1900 he was employed in the telephone manufacturing department and the electrical laboratory of the Western Electric Company in Chicago; the next four years were spent in the engineering and sales departments of the Kellogg Switchboard and Supply Company, Chicago. Then for a long period—until 1916—he was connected with the Dean Electric Company and its successor, the Garford Manufacturing Company of Elyria, Ohio, where for four years his service was as chief engineer. Since that date he has been with the Stromberg-Carlson Telephone Manufacturing Company, Rochester, and is now its chief engineer and one of its vice presidents.

During his affiliation with the manufacturing business, he has taken out over fifty patents on inventions in telephone, phonograph, and radio fields. He has been active also in radio standardization work in the Radio Manufacturers Association. For several years, he has been serving also as chairman of the electro-acoustic subcommittee of the I. R. E.

### PHILIPPINE COMMUNICATION FACILITIES IMPROVED DURING 1930

**C**OMMUNICATION facilities in the Philippine Islands were greatly improved during 1930, and should stimulate business considerably when other basic economic conditions permit.

Radio communication had many changes during the year, with the Mackay Radio and Telegraph Company and the Radio Corporation entering the Philippine field, and the Radio Corporation of the Philippines losing control of the nine provincial radio stations it had been operating because of the refusal of the Philippine Government to renew the franchise. The permanent status of these nine stations will probably be determined by the next legislature. The Bureau of Posts is now operating 63 radio stations, of which 12 were added during 1930. The following is a summary of radio stations in the Philippines: U. S. Navy, one official station; Mackay Radio and Telegraph Co., one transoceanic station; Radio Corporation of the Philippines,

one transoceanic station; Dollar Steamship Co., one shore station; Bureau of Posts, 63 domestic stations. The Philippine budget for 1931 contains an item of 246,000 pesos (about \$123,000) for operation of radio stations. (Trade Commissioner E. D. Hester, Manila, P. I., 1/20/31.)

### EDWARD GOODRICH ACHESON

Edward Goodrich Acheson, a pioneer in the field of applied electricity and best known for his production of silicon carbide ("carborundum"), electro-furnace graphite (Acheson-Graphite) and a method of colloidalizing substances by the Deflocculation Process, has been honored twice during the past year with permanent exhibits of an educational and historical nature which depict salient incidents in connection with his life and work.

The Acheson Exhibit at the Smith-



EDWARD GOODRICH ACHESON

sonian Institute, Washington, D. C., includes in addition to the various medals awarded Dr. Acheson for his accomplishments in electro-thermics, early incandescent lamp filaments fabricated during Acheson's association with Edison at Menlo Park, a reproduction of his first electric furnace, and original paper on *Lightning Arresters and a Photographic Study of Self-Induction*, together with specimens of tungsten wire and electrical resistors produced with the aid of colloidal graphite.

A collection of the various products produced commercially by Dr. Acheson, all of which were at some time manu-

factured at Niagara Falls, makes up the nucleus of the exhibit in his honor now on view in the rooms of the Niagara Falls Historical Society.

Aquadag Colloidal-Graphited Water and Oildag Colloidal-Graphited Oil, which represent but two of Dr. Acheson's many contributions to mankind, are well known to the radio industry where they find utility in the manufacture of tone controls, volume controls, grid-leaks, tungsten wire, "getters," clamp-paste; photoelectric cells, secondary-emission retardants and as lubricants.

### LOG RECORDS AT BROADCAST STATIONS

**A**T a session of the Federal Radio Commission held in Washington on February 16, 1931, an order effective March 1, was issued directing that all broadcasting stations maintain two log records, as follows:

1. *Program Log.* This log shall contain:

- (a) An entry of all stations and call announcements and the time made.
- (b) An entry describing each program broadcast with the time beginning and ending. If phonograph records or electrical transcriptions are used that fact shall be noted, together with the announcement made thereof.

2. *Operating Log.* This log shall contain:

- (a) An entry of the time the station's carrier wave goes on the air and the time the station's carrier wave is stopped.
- (b) An entry of the time the program begins and ends.
- (c) An entry of every interruption of the carrier wave, its cause and duration.
- (d) An entry of each of the following shall be made every thirty minutes.
  - (1) Operating constants on last radio stage (total plate current and plate voltage); antenna current.
  - (2) Frequency check.
  - (3) Temperature of crystal chamber (if used).

These logs shall be kept by the person or persons competent to do so, having actual knowledge or information of the facts herein required, who shall sign the log when coming on duty and again when going off duty. The logs herein required shall be open to inspection at all reasonable times by Government radio inspectors and other persons authorized to do so by the Federal Radio Commission.

VARI

5  
 RA  
 RA  
 "The TUBE"

... makes up  
... in his honor  
... oms of the  
... ociety.  
... nited Water  
... phuted Oil,  
... o of Dr.  
... ns to man-  
... ne radio in-  
... ility in the  
... ols, volume  
... rsten wire,  
... photoelectric  
... ardants and

DADCAST

... deral Radio  
... Washington  
... order effec-  
... irecting that  
... maintain two

g shall con-

ions and call  
... the time

g each pro-  
... th the time  
... ending. If  
... ls or elec-  
... s are used  
... noted, to-  
... nouncement

g shall con-

ime the sta-  
... goes on the  
... me the sta-  
... is stopped.  
... me the pro-  
... nds.

interruption  
... its cause

of the fol-  
... made every

onstants on  
... (total plate  
... ic voltage);  
... nt.

ck.  
... of crystal  
... ed).

by the per-  
... do so, hav-  
... orination of  
... who shall  
... on duty and  
... y. The logs  
... en to inspec-  
... by Govern-  
... l other per-  
... the Federal



# Simplifying 1931 circuits... THE NEW VARIABLE-MU TUBE

THE constant quest for improved, yet simplified circuits never ends for radio engineers.

Now, for 1931 receivers, Arcturus presents the new Variable-Mu Tube, Type 551. This tube contributes vital advances of great interest to set engineers... vastly improving operating efficiency of any receiver and making possible definite economies and simplification of the circuit arrangement.

The Arcturus Type 551 Tube renders unnecessary the use of double pre-selectors, dual volume controls; eliminates the necessity of a "loaf-long distance" switch.

This new Variable-Mu tube permits distortionless operation with signal input voltages approximately 25 times greater than with present-day tubes and extends the range of automatic and manual volume controls by this factor. It divides maximum cross-talk by five hundred. And it effects a marked reduction in receiver "hiss."

This is accomplished by a new principle in construction whereby the current-voltage characteristic is specially shaped so as to reduce the higher-order parameters responsible for distortion and cross-talk.

A special technical bulletin on the Arcturus Type 551 Variable-Mu Tube will be sent to manufacturers, engineers, and all others interested in this new development.

ARCTURUS RADIO TUBE CO.  
Newark, N. J.



... under patent applications of  
... Research Corporation

# ARCTURUS RADIO TUBES

'The TUBE with the LIFE-LIKE TONE'

© A. R. T. Co., 1931



# AEROVOX BUILT BETTER CONDENSERS AND RESISTORS

## Manufacturers of The Most Complete CONDENSER and RESISTOR Line in Radio

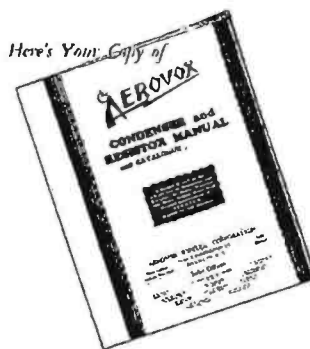

This interesting and helpful 40-page Manual and Catalogue containing a wealth of information on condensers and resistors and detailed electrical and mechanical data on the complete line of Aerovox Condensers and Resistors.

Sent Free on Request



The Aerovox Research Worker is a free monthly publication issued to keep radio engineers, experimenters and servicemen abreast of the latest developments in receiver and power supply design, and especially with the proper use of condensers and resistors. A request on the coupon below will place your name on the mailing list.

### Fill in and Mail the Coupon Below

AEROVOX WIRELESS CORP.,  
70 Washington Street,  
Brooklyn, N. Y.

Gentlemen:

Please send me without charge or obligation:  
( ) Your 40-page Condenser and Resistor Manual and Catalogue.  
( ) The Research Worker.

Name.....  
Street.....  
City..... State.....

# AEROVOX WIRELESS CORP. 76 Washington Street, Brooklyn, N. Y. PRODUCTS THAT ENDURE



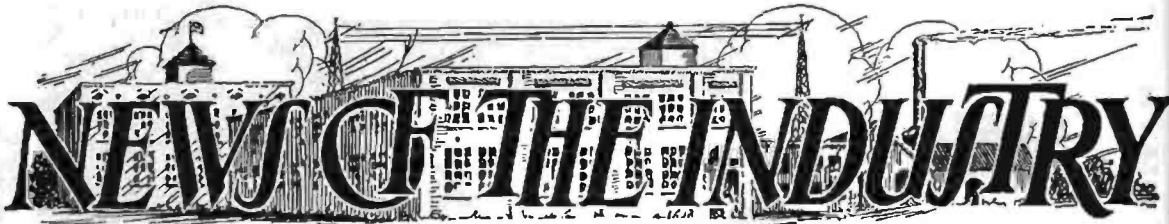

# NEWS OF THE INDUSTRY

## I. R. BAKER ADVANCED

Announcement of the promotion of I. R. Baker to manager of broadcast transmitter sales of the RCA-Victor Company, has just been made by Quinton Adams, manager of the engineering products division of that company.

Mr. Baker joined the RCA-Victor Company two years ago as a member of the broadcast transmitter sales section. Previously, he had been engaged in broadcast transmitter development work for the General Electric Company at Schenectady, where he took part in the extensive experimental work on high power radio transmission carried on through station WGY. Mr. Baker is a graduate of Gettysburg College.

## AEROVOX APPOINTMENT

The Aerovox Wireless Corporation, manufacturers of condensers and resistors, announce the appointment of L. H. Jackman, 2043 East 77th Street, Cleveland, Ohio, as representative of the Aerovox line in the Cleveland territory. Mr. Jackman, formerly of Ohio Carbon, is well known throughout the entire industry.

## ARCO ELECTRICAL CORPORATION

S. A. Lehman, president of the Arco Electrical Corporation of Fort Wayne, Indiana, announces the removal of the Chicago plant to Niles, Michigan. Although the machinery formerly in the Chicago plant has just been moved to Niles, operation at the new location has been in effect for several weeks with the new special machines for coil production work.

The Arco company is doing contract work for radio and electrical manufacturers, building coils, chokes, transformers and special windings to specifications.

W. A. Hudson, division manager, is in charge of the Niles plant and G. McL. Cole, chief engineer, is in charge of the engineering staff. Mr. Lehman has charge of the Fort Wayne plant and the executive offices.

Display space has been acquired in the new merchandise mart in Chicago, where a complete line of Arco products is continuously on display in charge of a competent coil engineer.

## FANSTEEL NOW OFFERS TUNGSTEN

Adjustment of certain patent restrictions now permits Fansteel Products Company, Inc., North Chicago, Illinois, to sell pure tungsten metal in all commercial forms for general purposes.

This company has manufactured tungsten since 1914, but has sold the pure metal only in the form of finished electrical contact points. However, they have produced certain tungsten-molybdenum, tungsten-tantalum and tungsten-copper alloys, as well as pure molybdenum and tantalum, and are experienced in working these metals and drawing them into fine wire. Only slight adaptations in the technique and equipment which Fansteel already has thus developed were necessary to produce fine drawn wire of pure tungsten.

Unusual purity and workability are characteristic of Fansteel tungsten. The metal is refined from the Chinese ore (wolframite), or other basic materials, to tungstic acid, which is converted to salt and

back to acid three times in order to eliminate impurities. The pure acid, after being sampled by the laboratory, is ignited to oxide which is reduced in hydrogen furnaces to 99.95 per cent tungsten powder.

This powder is pressed into bars under pressures of several hundred tons, and the bars are converted into ingots by sintering, which consists of heating the bars electrically in special furnaces from which all oxygen is excluded.

Sintering, when carefully controlled, starts a regular metallic crystal growth which is continued by swaging the ingots into rods of decreasing diameter and finally drawing them into wire through drilled diamond dies. Ingots are also rolled into sheets for certain purposes.

Pure tungsten is an interesting material. It has the highest melting point of all metals. It retains rigidity at higher temperatures than any other metal. It has the lowest vapor pressure of all metals, and, in the form of drawn wire, has greater tensile strength than any other known material.

## SIMPLEX HAS GOOD YEAR WITH MIDGETS

At the annual meeting of The Simplex Radio Company, Sandusky, Ohio, H. C. Maibohm, president, reported an increase of 240 per cent in net earnings for 1930 over 1929, the company's best previous year.

"Approximately three times as many radio sets were sold as in 1929 and the company attributes its highly successful year almost entirely to its foresight early in the season in sensing a public demand for the now popular priced midget types and concentrating its major production activities on an excellently engineered and substantially built small radio in three cabinet types varying in price from \$49.50 to \$59.50, less tubes.

The following officers and directors were re-elected: H. C. Maibohm, president and treasurer; J. M. Grusch, vice-president and works manager; W. C. Creman, vice-president and chief engineer; R. J. Ommert, secretary; and M. B. West, consulting engineer.

## C. J. HIRSCH TO FADA

Frank Andrea, president of the Fada Radio Company with headquarters at Long Island City, has announced the appointment of Charles J. Hirsch to the staff of the Fada research laboratories. In announcing the news of this appointment, Mr. Andrea stated, "As pioneer radio manufacturers, established in 1920, it has always been our endeavor to keep pace with every new development in the art of radio. These developments and new designs are thoroughly tested by our own Fada research laboratories.

"Charles J. Hirsch, latest addition to the Fada staff is a graduate electrical engineer with a wide experience in radio work. He is holder of several patent applications on radio and similar apparatus and recently has been engaged in research work with the Radio Frequency Laboratories in Boonton, New Jersey.

"He was also associated with the Hammond Laboratories of Gloucester, Mass., in research in synchronizing apparatus for facsimile transmission, short wave transmission and airplane radio apparatus.

"Mr. Hirsch has also worked with the Edison Laboratories in Orange, N. J., on research pertaining to phonograph recording apparatus."

## DAVIS NEW HEAD OF PHILCO BOARD

Important changes in executive personnel, including the addition of two new officers to the company, were announced recently by the Philadelphia Storage Battery Company, makers of Philco radios.

Edward Davis, president and one of the founders of the company, has been elevated to the position of chairman of the board of directors, and James M. Skinner, vice-president and general manager, becomes president.

The two new officers are George E. Deming, new executive vice-president, and Walter E. Holland, who becomes vice-president in charge of engineering. Deming was formerly works manager, and Holland was chief engineer. He is nationally known in the industry for his work as chairman of the engineering committee of the Radio Manufacturers Association, and for the technical developments he has sponsored and inaugurated as Philco's chief engineer.

## CENTRAL RADIO CORPORATION

A letter received from W. T. Bracken, general manager, Central Radio Corporation, Deloit, Wis., reads:

"This company has been advised that R. G. Dun and Company has issued a special notice that Central Radio Corporation, North Wells Street, Chicago, has filed a voluntary petition in bankruptcy. That company, we have been informed, is a non-operating defunct concern, which formerly had some connection with Moulded Wood Products Company.

"On account of the name being identical to ours, we are very anxious to have everyone understand that the Chicago company is not and never has been connected with our company in any way. You can appreciate the embarrassment that we would be caused, should our suppliers and customers be misinformed on this matter."

## KESTER SOLDER COMPANY ELECTION

At a meeting of the board of directors of the Kester Solder Co., Chicago, on February 17, F. C. Engelhart was elected president of the company.

Mr. Engelhart has been the directing head of the company for twenty years, acting in the position of general manager and treasurer. Under his guidance the company has grown from a small organization to the present large and complete plant at 4201 Wrightwood, Chicago, and also a plant in Newark, New Jersey.

It is further announced that J. A. Reitzel, formerly sales promotion manager, has been elected to the position of general sales manager. Mr. Reitzel has had a broad experience in sales and advertising, having occupied executive positions with the Portland Cement Association and other well known organizations.

## FELT FEET FOR MIDGETS

The T. R. Brawley Felt Co., Inc., 279 20th Street, Brooklyn, N. Y., manufactures a complete line of felt feet for midget radio receivers. Equipped with Brawley felt feet receivers may safely be set down on polished surfaces without danger of scratches or marks.

RY

OF PHILCO

utive personnel,  
new officers to  
ed recently by  
tery Company,

and one of the  
s been elevated  
of the board of  
Skinner, vice-  
nager, becomes

George E. Dein-  
president, and  
comes vice-presi-  
g. Deming was  
and Holland was  
nally known in  
is chairman of  
of the Radio  
and for the  
s sponsored and  
f engineer.

RPORATION

V. T. Bracken,  
Radio Corpora-

advised that  
has issued a  
Radio Corpora-  
Chicago, has  
in bankruptcy.  
n informed, is  
concern, which  
n with Moulded

being identical  
to have every-  
icago company  
connected with  
You can appre-  
we would be  
and customers  
er."

OMPANY

l of directors  
icago, on Feb-  
elected presi-

the directing  
nty years, act-  
manager and  
nce the com-  
ll organization  
mplete plant at  
d also a plant

that J. A.  
tion manager,  
sition of gen-  
nitzel has had  
and advertis-  
ive positions  
association and  
ons.

DGETS

Co., Inc., 279  
manufactures  
midget radio  
wley felt feet  
down on pol-  
of scratches

# COST PER TUBE IS LOWER WITH TANTALUM

—National Radio Tube Company  
Prominent Pacific Coast  
Manufacturing Company



"WE find with the use of Tantalum," writes the General Manager of National Radio Tube Company, "that our cost per tube is lower even though Tantalum costs more than some other materials.

"This material reduction in cost is due to the fact that Tantalum is such an efficient 'getter,' and serves to enhance the quality of our product to such an extent that our loss in gassy tubes is negligible.

"Also, we are thankful for your Tantalum Alloy spring wire which has already repaid us a thousand times by insur-

ing us against flabby filaments. Our engineers recommend the use of Tantalum in all tubes where extremely high vacuum is essential to long life and perfect service."

The findings of this company are backed up by those of other producers both here and abroad who are turning more and more to Tantalum to solve technical difficulties,

improved quality and lower costs.

When you try Tantalum, you'll be surprised at the ease with which it can be stamped, formed, welded and cleaned. It's available in rod, sheet, and wire. May we send you a sample?

*Fansteel is your best source of supply also for pure Molybdenum, hardened Molybdenum alloys, photo-cell metals and salts. Ample stocks for immediate delivery. Information and prices on request.*

**FANSTEEL PRODUCTS COMPANY, INC.,**  
NORTH CHICAGO, ILLINOIS

**TANTALUM · TUNGSTEN · MOLYBDENUM · CAESIUM · RUBIDIUM AND ALLOYS**



# “Projection Engineering”

*The Journal of the “Sound” Industries*

Published monthly, and dealing with the manufacture, engineering, service, installation and operation of public address systems, centralized radio, theatre talkies, home talkies. Covering the subjects of design, production, materials, acoustics and the practical problems encountered by field engineers, contractors installation men and service men.

A.B.C.  
PAID

CIRCULATION  
OVER 9,000

in the

Electronic

or

“Sound”  
Industries

## A PRESENT MARKET OF PROVEN AVAILABILITY

Public Address  
Sound Amplifiers  
Sound Recording  
Sound Pictures  
Home Talkies  
Visual Projection  
Sound Reproducers  
Acoustic Engineering  
Automatic Music  
Photo Tubes  
Amplifier Tubes  
Industrial Sound  
Applications  
Industrial Visual  
Applications

Projection Engineering, with a paid A.B.C. Circulation of over 9,000 engineers, executives, technicians, contractors, service and installation men and projectionists, has the largest paid circulation of any publication among the *new*, radio associated, electronic or “sound,” industries.

The editorial staff is headed by Donald McNicol, past president of the I. R. E.

The subscription rate is \$2.00 a year (no newsstand circulation)—\$3.00 for 2 years. (\$3.00 yearly in foreign countries.)

*Published by the*

**Bryan Davis Publishing Co., Inc.**

52 Vanderbilt Ave.

New York City

Cleveland

Chicago

Los Angeles



Benjamin  
Franklin  
1706  
with  
writing  
a bill  
the De  
found  
the  
the  
of the



Voltaire  
1712  
the  
of the

Voltaire  
1712  
the  
of the  
great  
length  
the  
material.

ALE  
Alcra  
ten  
cover  
pedic  
col  
in coll  
w  
consider  
conduc  
particula  
little  
mensura  
compo  
open  
many  
nomica  
ressed  
by the  
ell  
The av  
In all co



# NEW DEVELOPMENTS OF THE MONTH

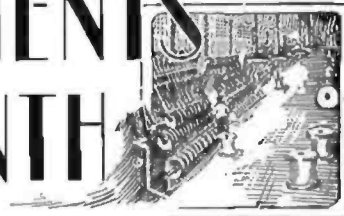

## DE JUR-AMSCO

Benjamin Prier, sales manager of DeJur-Amsco Corporation, 95 Morton Street, New York City, manufacturers of variators, variator-condensers and power rheostats is on his semi-annual trip, during which he will call on radio set manufacturers between New York and the coast. DeJur-Amsco Corporation has just issued a circular describing in detail a new variator, a small fixed-capacitor, designed to meet the



requirements of the semi-variable or "fixed" capacitors in modern radio frequency and superhet circuits. The DeJur-Amsco Corporation will be glad to send a copy of this circular to anyone upon request.

## VULCANIZED FIBRE

Vulcanized Fibre, as manufactured by the General Diamond Fibre Co., Newark, N. J., is recognized by engineers and factory managers everywhere as a "general purpose" material, but it is doubtful if these individuals who use this product for some specific application, appreciate its wide range of utility.

Vulcanized Fibre, first produced in the early days of the electrical industry, and the development of which has kept pace with that industry, is frequently looked upon solely as an electrical insulator, when, as a matter of fact, it has found many important uses in industries in no manner related to the electrical industry.

Vulcanized Fibre is a hard, dense, bone-dry material, tough, pliable and strong. Its great physical strength, high dielectric strength and adaptability to all machining operations make it a universal raw material.

## ALECTRAL MAGNET WIRE

Alectral magnet wire, of enameled, cotton covered, or silk covered aluminum, for radio coils, accomplishes a distinct saving in coil weight, as will be evident upon full consideration of weight ratios for equal conductivities. It is recommended as being particularly desirable for use in coil constructions where the slightly increased dimensions of the Alectral coil of equivalent ampere turns does not involve an undue increase in form. It is recognized that in many types of coil construction the economies of Alectral may be offset by increased length of magnetic circuit required by the larger dimensions of the Alectral coil.

The availability of aluminum magnet wire in all commercial forms of covering and in

all but the extremely fine sizes now gives coil engineers the opportunity of considering the possible advantages of Alectral magnet wire in his own coil construction with the full assurance of a dependable source of supply having incomparable experience in magnet wire manufacture.

This product is offered by the General Cable Corporation, 420 Lexington Avenue, New York.

## RADIO-PHONOGRAPH COMBINATION

An entirely new automatic phonograph record-changing device for use in instruments for the home, has just been announced by The Capehart Corporation of Fort Wayne, Indiana. The new mechanism has been developed especially for manufacturers of radio-phonograph combinations, and will be available to the public in the instruments of a number of leading makers in their 1931 lines.

The new record changer embodies many exclusive features, according to H. E. Capehart, president of the corporation. Chief among its advantages are compactness and positive, dependable operation. It will accommodate both 10-inch and 12-inch records. Naturally this compactness enables a complete radio-automatic phonograph combination in a much smaller-size cabinet than has been possible heretofore. At the same time, of course, the unit performs equally well in cabinets of the ordinary and larger sizes.

In announcing the new unit Mr. Capehart said that although it had only recently been presented, following exhaustive tests of its operation in the Capehart laboratories, the mechanism has been enthusiastically received by radio manufacturers and distributors. Negotiations have already been completed for its inclusion in instruments which will soon be presented to the trade and public.

## WIRE WOUND CONTROL UNIT

The illustration herewith is of a dual wire wound control unit manufactured by The Wirt Company, 5221-27 Greene Street, Germantown, Pa. The resistance coils are completely housed in a black bakelite case which protects it from the outside elements



and it is practically noiseless. The diameter of this control is 1 1/4 inches and is one inch deep.

## HIGH-VOLTAGE ELECTROLYTIC CONDENSER

After two years of research and engineering development on electrolytic condenser problems, the Dubilier Condenser Corporation, 4377 Bronx Blvd., New York City, announces the Dubilier Hi-Mike condenser—a refined, semi-dry, high-voltage electrolytic condenser with the following outstanding features:

Aluminum can 4 1/2 by 1 1/2 inches, interchangeable with other standard electrolytic units. Available in upright and inverted mounting types. Standard capacity of 8 mfd., with exceptionally high percentage of



effective capacity. Working voltage conservatively rated at 400, with peak of 430, or more than ample for requirements of set with -80 type rectifier. This condenser is fully self-healing, reforming rapidly and has low leakage at high voltages. The life expectancy is in excess of requirements of the usual radio assembly.

Due to the numerous refinements incorporated in the new Dubilier Hi-Mike condenser, the use of electrolytic condensers in standard filter circuits makes for economy without sacrificing practicability. The units are compact, clean, non-spillable and, due to minimum leakage, quite efficient, providing ample filtering action for most requirements.

## POWER SUPPLY PANELS

R. C. Powell & Co. Inc., of 350 Madison Avenue, New York City, has recently developed a complete line of power supply panels ranging in capacity from a few hundred watts required for sound systems and broadcast studio equipment to a maximum of 400 Kilowatts for high power installations, including a variety of designs for use in medium power broadcasting stations. The rectifiers employ mercury vapor tubes which are particularly adapted for vacuum tube equipment because of the excellent voltage regulation under varying load conditions. They are designed for single and three phase commercial line supply and contain built-in filter systems which deliver a virtually pure d-c. output.

A.B.C.  
executive  
and  
as the  
education  
tronic  
Mc-  
news-  
(\$3.00  
Inc.  
Angeles

### A MUTUAL CONDUCTANCE METER

The Weston Electrical Instrument Corporation of Newark, N. J., has developed a new instrument for the direct measurement of the mutual conductance of radio tubes having an amplification factor between 3.5 and 42, and of all screen-grid tubes.

The instrument is of the copper oxide rectifier type with a 7¼ inch diameter case for flush mounting. A compensator mounted in a box approximately 3½ by 7 inches is supplied as a part of the instrument. This box is arranged for surface mounting.

To measure the mutual conductance of a tube it is necessary to apply one volt, 60-cycle a-c. to the grid. The other elements of the tube are energized with their standard rated d-c. voltage and the compensator dial is set for the value most nearly corresponding to the mu of the tube under test. The mutual conductance is read direct on the scale.

The signal voltage of exactly one volt is easily obtained by means of a small step-down transformer with a 1.5 volt voltmeter and a potentiometer connected across the secondary so that the voltage may be adjusted in case of variations in the line voltage.

### NON-AQUEOUS CONDENSERS

The P. R. Mallory Company, Elkon Division, Indianapolis, Ind., in October last introduced the non-aqueous Hi-volt condenser. This is a high grade filter condenser. The condenser is self-healing and operates at 450 volts d-c. It is not injured on transient peaks even in excess of 600 volts. Various receiving radio set manufacturers have adopted this condenser unit as standard for their products.

### ERIE RESISTORS

A large radio manufacturing company reports having found Erie resistor units 99½ per cent perfect. Out of millions of resistor units supplied less than five out of every thousand were on test found to be below standard.

Erie resistors are said to have a constant resistance value, not affected by age or temperature.

The Erie Resistor Corporation is located at Erie, Penna.

### C. R. S. SOCKETS

The Central Radio Corporation, Deloit, Wis., is a pioneer manufacturer of tube sockets. This year's model is No. 700 socket, designed to meet new and up-to-date manufacturing needs. The contact is backed by a steel reinforcing ring, and full insulation of high quality Bakelite is provided in these parts.

### ACME ELECTRIC AND MFG. CO.

The Acme Electric and Manufacturing Company, 1440 Hamilton Avenue, Cleveland, Ohio, manufactures a line of step-down transformers for export to countries where voltage ranges from 200 to 240 volts; 50- or 60-cycles, also for 150- 165-volts primary.

### RESISTANCE UNITS MEASURE INFINITESIMAL VALUES

As every graduate of high school physics knows, electrical resistance is measured in ohms. With the development of radio, however, entirely new conceptions of both force and matter came into existence. Toward both the infinite and the infinitesimal man's mind, by means of radio, explored regions never before delved into. One of these fields is that of electrical resistance.

The need for resistors in value from 10 to 20 megohms rating has long been met by metallized resistors, the metallized fila-

ment being mounted and hermetically sealed in heavy glass tubes, from the metal end-caps of which pigtail leads protrude.

In recent months the engineering staff of the International Resistance Company of Philadelphia has gone exploring in still more rarified strata of electrical resistance. Astronomers, using delicate radio grid-glow tube circuit instruments with which to measure the electrical currents generated by the light rays from the planets, required for their delicate measuring instruments resistors of values as high as 10,000 megohms or ten billion ohms. So by research in the far reaches of electrical resistance and the production of resistors of 10,000 megohms value astronomy is aided in peering into space so infinite in extent that it is measured not in miles but in light years, the distance traveled by light in one year at the speed of 186,000 miles per second.

These high resistance metallized resistors are likewise aiding in the measurement of quantities and distances so small as to be almost inconceivable to the human mind. Instruments incorporating high value metallized resistors can measure such minute distances as that which a three-foot wall bends when leaned against, or the bending of a one-inch steel bar when a fly alights upon it.

### LIGHT WEIGHT HEADPHONE

The Trimn Radio Mfg. Co., Chicago, Ill., has developed a new "feather-weight" headphone that has won acclaim wherever presented.

This new headphone will probably find its widest application in aiding the hard of hearing, not only permitting them full enjoyment of radio programs, but also bringing them sound movies, lectures, church services, improved audition in the theatre, and the like.

Because of its small dimensions, feather-weight and extreme sensitivity it is particularly appropriate for airplane service, as it fits readily into the pilot's helmet. It is ideal for short wave sets and it has already a wide application in hospital and hotel service.

The new feather-weight Trimn receiver is only one and thirteen-sixteenth inches in outside diameter, three-quarter inch at its greatest thickness and weighs but one and one-half ounces.

The unit is wound in any desired impedance, and the receiver is equipped with a thin steel head band and light-weight cord, three, six or twelve feet long.

### REPLACEMENT TRANSFORMER CHART

A replacement transformer chart has just been brought out by the Dongan Electric Manufacturing Company of Detroit. In this chart are listed the types of power transformers required for the various models of the popular makes of radio receivers.

With the large number of sets now doing duty there is a considerable parts replacement market. The Dongan chart, in addition to the listings, contains much valuable information for those engaged in catering to that market.

A Dongan chart may be secured by writing to that company at Detroit, Michigan.

### TRANSFORMER CORE MATERIAL

A review of the nickel industry for 1930, written by A. J. Wadhams, manager of development and research for The International Nickel Company, Inc., says, in part:

"Use of ferro-nickel alloys of the permalloy type, containing up to 78 per cent nickel, to counteract the capacity effect of long distance transmission lines, now is quite general. Another alloy of this type, containing 45 to 50 per cent of nickel, has been used with marked success for audio transformers for radio receiving sets, and the use of a similar product is being considered for the construction of lighting and power transformers."



### REPLACEMENT RESISTORS

The Tilton Mfg. Co., 15 East 26th Street, New York, is marketing a resistor pocket for servicemen, containing 24 of the most needed sizes of resistors now in use. The name of the package is the ex-stat pocket kit.

### DUREZ

Durez, manufactured by General Plastics, Inc., North Tonawanda, N. Y., a synthetic resin molding compound, was introduced in 1919. Its acceptance is general where hot press molding compounds are used today and it is used exclusively by several of the largest organizations in the world, among the better known being Ford Motor Co., Delco Remy Division of General Motors, Atwater Kent, Western Electric, General Electric, and Westinghouse.

### NEW TEST OSCILLATOR

The Radio Products Company, Dayton, Ohio, is marketing a new and widely useful test oscillator.

This instrument is a fixed frequency oscillator having a frequency change switch with four settings. The first setting sends out a self modulated signal of 130 kc., the second setting sends out a self modulated signal of 175 kc. on which a vernier is arranged for changing the frequency in one kilocycle steps from 170 to 183 kc. These two settings comprise the requirements for intermediate frequency amplifiers of super-heterodyne receivers. The third setting operates on the harmonics of 250 kc., throwing out four simultaneous self-modulated signals at frequencies of 750, 1000, 1250 and 1500 kc. The fourth setting, sends out simultaneous signals in harmonics of 200 kc., namely, 600, 800, 1000, 1200 and 1400 kc. The instrument is operated from battery, compartments for which are arranged in the case, the tube being 230 type, filament operating from four unicells in series parallel, one 2½-volt B battery for plate. The assembly is thoroughly shielded, and has a satisfactory volume control, the entire assembly then is enclosed in highly finished quartered oak case with convenient carrying strap. The hinges on the case lid are slip hinges which of course are easily removed so that the instrument can be used with facility in the shop or for portable work.

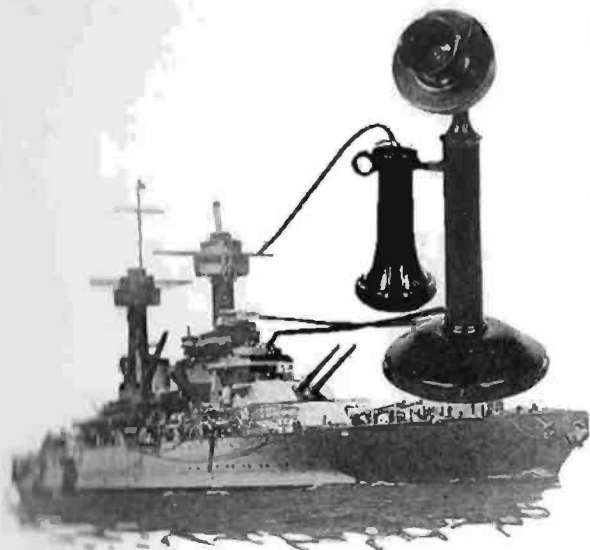

On your office desk . . .  
 . . . and a battleship deck  
 . . . FELT

**A** GRAPHIC example of the hundreds of uses of Felt. Felt gaskets in the mighty, throbbing turbines of the battle-wagon and a felt pad between your telephone and desk.

Will you let us show you how Felt may be intelligently utilized in your business? The American Felt Company, largest felt manufacturers in the world, maintains a staff of experts anxious to serve you. It is only good business sense to avail yourself of such cooperation.

Felt is supplied in bulk or cut to the most exacting specifications.

Now is the time to investigate!

## American Felt Co.

NEW YORK BOSTON SAN FRANCISCO DETROIT  
 CHICAGO PHILADELPHIA ST. LOUIS

AMERICAN FELT CO., 316 FOURTH AVENUE, N. Y. C.

We are interested in the use of felt.

Send sample for \_\_\_\_\_

Have your representative call.

Name \_\_\_\_\_

Address \_\_\_\_\_

**RESISTORS**

at 26th Street,  
 resistor pocket  
 4 of the most  
 in use. The  
 ex-stat pocket

General Plastics,  
 a synthetic  
 introduced in  
 where hot  
 used today  
 several of the  
 world, among  
 Motor Co.,  
 General Motors,  
 General

**ATOR**

pany, Dayton,  
 widely useful

frequency oscil-  
 lation switch  
 setting sends  
 of 130 kc., the  
 elf modulated  
 vernier is ar-  
 quency in one  
 83 kc. These  
 requirements for  
 bers of super-  
 third setting  
 of 250 kc.  
 us self-modu-  
 of 750, 1000,  
 setting sends  
 harmonics of  
 200, 1200 and  
 operated from  
 which are ar-  
 eing 230 type,  
 r unicells in  
 B battery for  
 ighly shielded,  
 c control, the  
 used in highly  
 ith convenient  
 n the case lid  
 rse are easily  
 it can be used  
 for portable

# Look at that Edge

It shows plainly why  
 it is called . . .

**"SEALEDGED"**  
 (Reg. U. S. Pat. Off.)



Above is a  
 micro-photo-  
 graph of a  
 piece of "Seal-

edged" Nickel Wire Cloth enlarged many times to show you the extraordinarily even edge and our method of sealing it to prevent unraveling. Note, also, the perfect weave and smooth finish of this widely used electron tube component.

"SEALEDGED" is produced by special machinery of great precision, to give you a wire cloth of superlative qualities. Due to its mechanical regularity of construction, uniform performance is assured.

"SEALEDGED" is 99 + % PURE NICKEL—made of the purest material obtainable—and costs only a trifle more than common raw cut wire cloth.

Tell us your requirements. Glad to send you a sample of this uniform, mechanically correct and chemically pure nickel wire cloth.

## Newark Wire Cloth Co.

358-372 Verona Ave.

NEWARK

NEW JERSEY

Without obligating us in any way please send sample and further particulars concerning "SEALEDGED" Grid Screen.  
 Please send representative.

Name \_\_\_\_\_

Firm \_\_\_\_\_

Street \_\_\_\_\_

City \_\_\_\_\_ State \_\_\_\_\_

## 112 BROADCAST STATIONS IN 41 STATES USE OUR EQUIPMENT



100 KW Rectifier Control Panel

We are prepared to submit quotations on the installation of complete broadcasting plants.

Inquiries regarding new equipment or the modernization of your present station, will receive our prompt attention.

**R. C. POWELL & CO., Inc.**  
350 MADISON AVENUE  
NEW YORK CITY

*Engineers Specializing in Radio Telephone Equipment.*

# ACRACON



## The Solution to Your Condenser Problems!

**N**O longer need you worry over your condenser problems. Not if you follow the example of the many leading manufacturers who have learned to rely on Acracon\* Condensers for quality, dependability, and efficiency.

Be wise in 1931! Specify Acracon for every condenser requirement. Electrolytic. By Pass. Wax Impregnated. Oil Impregnated. Power and Transmitting types.

*Write Today Enclosing Your Specifications!*

\*"Acracon" Features Are Protected by Patents Pending

## CONDENSER CORP. OF AMERICA

259-271 Cornelison Ave., Jersey City, N. J.

*Factory Representatives In:*

ST. LOUIS    SAN FRANCISCO  
CHICAGO    CINCINNATI    LOS ANGELES    TORONTO

And Other Principal Cities

# ROEBLING

**MAGNET**  
(Cotton or Silk)

**BUS BAR**  
Litzendraht-Loop

**STRAND**  
Antennae (plain or enameled)  
---Double Galvanized.

**WIRE**  
Antennae (plain or enameled).  
Connecting and Ground (Rubber covered, braided or plain).

JOHN A. ROEBLING'S SONS CO.  
Trenton, N. J. Branches in Principal Cities

## WIRE PRODUCTS

### VOLUME CONTROLS POTENTIOMETERS FIXED RESISTANCES

After many months of development we are pleased to announce the perfection of a new process whereby we can save you money on the above items and give you closer limits and absolutely permanent values of resistances.

Send us your blue prints and specifications for estimates.

**SORENG-MANEGOLD CO.**  
771 Mather St.  
Chicago.

# GEN-ERAL COILS

Reg. U. S.: Pat.



CX 100—D. V. M.



R. F.—S. H. Antenna

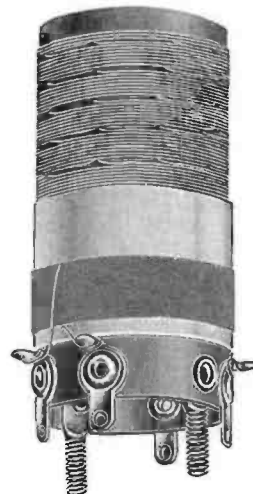

R. F. B. No. 100



S. H.—R. F. Oscillator



R. F. B. No 14

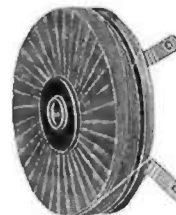

CX 100—Mounted



CX 200

**GENERAL MANUFACTURING CO.**  
8065 So. Chicago Ave., Chicago



## Service . . Handling the job to perfection . .

Motors built to dependably insure the full enjoyment of the radio-phonograph's highest achievements. Year in and year out. The popular Flyer Electrics.

They have abundant reasons for most satisfactorily so doing. Always they have been known for balanced efficiency. Always for simplicity of design. Always for dependability. Always they have consistently met every requirement . . .

kept right on proving their superiority, handling their job! Only Flyer Electrics have these advantages: Made by a concern with a quarter century of experience in specialized electrical manufacturing coupled with 15 years of leadership in large scale production of quality phonograph motors.

Specially designed for radio-phonographs. Used by leading builders of quality combinations.

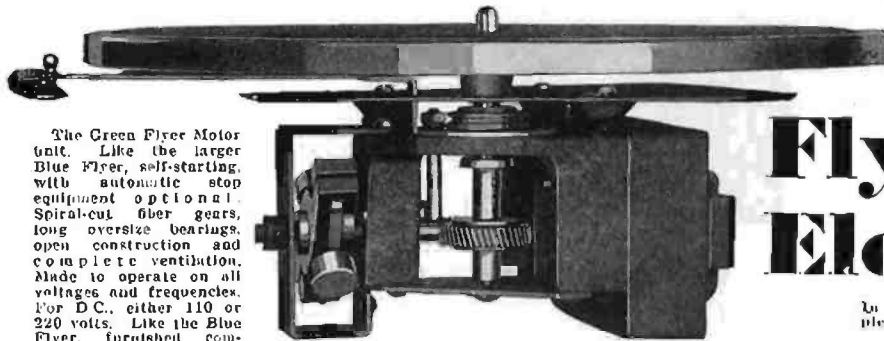

The Green Flyer Motor unit. Like the larger Blue Flyer, self-starting, with automatic stop equipment optional. Spiral-cut fiber gears, long oversize bearings, open construction and complete ventilation. Made to operate on all voltages and frequencies. For D.C., either 110 or 220 volts. Like the Blue Flyer, furnished complete with mounting plate, turn-table and speed regulator, as shown.

Responsibly Guaranteed

Ontario  
Hydro-Electric  
Power Commission  
Approval No. 2685



# Flyer Electrics

In ordering samples,  
please give voltage and  
frequency.

The **GENERAL INDUSTRIES CO.**  
3147 Taylor Street, Elyria, Ohio

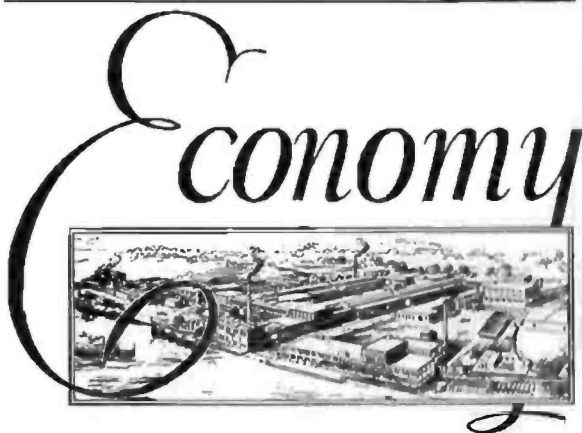

The purchasing power of The Zapon Company, and of Atlas Powder Company, its parent organization—makes possible the production and the sale of perfect lacquer at the lowest possible cost



PYROXYLIN  
LACQUER

**THE ZAPON COMPANY**

A Division of Atlas Powder Company  
STAMFORD, CONN.

# JOHNSON'S INDUSTRIAL TAPE

**D**OES not need a loud-speaker to broadcast its perfection.

Radio engineers all know of and recognize its superiority, its holding properties, lasting adhesion and non-corrosive action. It will outlast any other tape put to similar usage.

Write for free sample and convince yourself of its excellence

**JOHNSON & JOHNSON**  
New Brunswick, N. J.

# S. S. WHITE MOLDED RESISTANCE UNITS

*Successfully endure in ANY climate*

Planes of the Pan American Airways, Inc., carry Radio Equipment in which S. S. White resistors operate in the most gratifying manner.

**The S.S. WHITE Dental Mfg. Co.**  
INDUSTRIAL DIVISION  
Knickerbocker Bldg., New York, N. Y.

**PAN AMERICAN AIRWAYS, INC.**  
GENERAL OFFICE - 111 EAST 19th STREET - NEW YORK CITY  
May 6, 1930.

The S. S. White Dental Manufacturing Company,  
157 West 140th Street,  
New York, N. Y.

Attention: Mr. J. G. Brock

Gentlemen: This will acknowledge your letter of May 1st concerning the use of your resistors in our service.

Since we use your resistors in the aircraft receivers used on our planes, we have never had a failure while operating in tropical climates. These resistors in which your product is used have been flown in our aircraft all over South and Central America, Mexico and the West Coast of Europe. These units have been subjected to the most adverse climatic conditions imaginable and have never failed. They are used in a resistance coupled amplifier circuit as well as in our transmitters.

Very truly yours,  
S. S. White  
By G. Lovett  
Communications Division

P.A.A. Passenger: Titania and Terminus - P.A.A. Airport, Miami - P.A.A. Airliner: Fokker F-10 - Thriller, with motors idling in front of gangway, ready for passengers.



## Escutcheons - DIALS and NAME PLATES

—LICENSE PLATES—

Our large and modern plant affords excellent facilities for the speedy production of your requirements in etched and lithographed also



embossed metal specialties. A large variety of stock dies enables Radio Manufacturers to effect great savings on escutcheons, for regular models, Midget sets, and auto radio sets.

Cut slightly over half actual size. Send your blueprints—our Art Department will gladly submit original sketches for your approval.

**General Etching and Mfg. Co.**

MANUFACTURERS OF  
ETCHED AND LITHOGRAPHED  
METAL PRODUCTS

3070-82 W. Grand Ave., Chicago, Ill.

## JENKINS & ADAIR Condenser Transmitter



Type D-6  
Patented U. S. A. No. 1790508  
Other patents pending

A high quality sound translating device for broadcasting, recording sound measurement and announcing. Output impedance 200 ohms or 50 ohms.

Actuator response curves furnished for precision applications.

We have a large stock of accessories such as stands, suspension clamps, microphone booms, connectors, cable, etc.

Write for bulletin 6-D.

**JENKINS & ADAIR, INC.**  
ENGINEERS

CHICAGO, U. S. A.

Cable Address: JENKADAIH

Phones, Keystone 2130 3333 Belmont Avenue

British Office: 16 Old Mall Street, Liverpool, England

French Office: 10 Rue de Chateaudun, Andernach, France

Mexican Office: Av. 5 de Mayo 16, Mexico D.F., Mexico

## Instrument Resistors



Type LB

In the construction of apparatus employing electronic tubes and associated equipment, special types of Super Akra-Ohm (non-inductive) wire-wound Resistors have been found very desirable from the standpoint of mechanical dimensions and terminal facilities.



Type WE

### Super Akra-Ohm Resistors

As pictured above, are made in a variety of dimensions from 1/2" to 1 1/4" and a wide range of resistance values. They are conveniently mounted and incorporate all the valuable characteristics that have established the leadership of the Super Akra-Ohm Resistors.

Send us your resistance specifications and we will gladly submit samples and prices.

**Shallcross Mfg. Company**

**ELECTRICAL SPECIALTIES**  
 700 PARKER AVENUE  
 Collingdale, Pa.

## An Accurate TEST OSCILLATOR

>>> for \$2750

Send for details of this Oscillator and Output Indicator.

The DryRad Type 110 Multi-Frequency Test Oscillator providing Broadcast Signals at

(1) 600, 800, 1000, 1200, 1400 Kilocycles (simultaneously)

(2) 750, 1000, 1250, 1500 Kilocycles (simultaneously)

Intermediate Signals at

(1) 100 Kilocycles  
(2) 175 and 180 Kilocycles (Variable from 170 to 183)

Send for detailed circular or order from your Distributor.

Ask about Type 50 Output Indicator \$10.00

**THE RADIO PRODUCTS COMPANY**  
 Dept. E  
 5th and Norwood  
 Dayton, Ohio

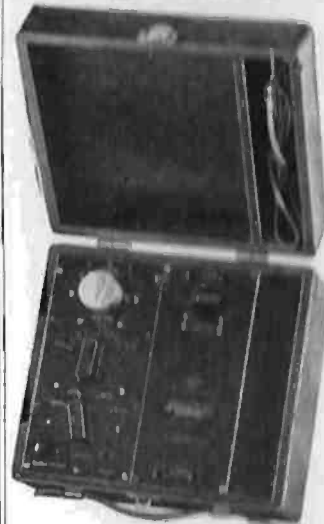

## Presenting . . . THE MID-WAY

FEATHERWEIGHT



"STANDARD" SIZE  
CARDWELL XMITTING—  
15 oz.



MID-WAY XMITTING—  
5 oz.  
Note difference in Bulk.  
Both photos same scale.

Receiving condensers 26 to 365 mmfds. capacity, airgap .030", occupying a panel space of only 2 3/4" x 2 3/8" and weighing from 4 to 7 ounces. (Suitable also for transmitters using '10 type tubes).

Transmitting condensers, equally compact and light, for transmitters using up to 75 watt tubes, capacity from 22 to 150 mmfds. airgap .070".

Particularly suitable for aircraft receiving and transmitting equipment, portable sets, oscillator-amplifier outfits or for any use where reduction in weight and bulk is desirable with no

sacrifice in solidity or strength. The construction is identical to that used in the full size CARDWELLS.

Further particulars will be sent upon request.

## CARDWELL CONDENSERS

»»»»

The Allen D. Cardwell Mfg. Corp.  
 87 Prospect Street Brooklyn, N. Y.  
 "THE STANDARD OF COMPARISON"

## Wireless Egert Engineering

179 Greenwich Street  
New York

### ANNOUNCING

A standard line of instruments designed for high frequency work.

Write for our Catalogue A

## D'Arcy Laboratories

place at your disposal their laboratory facilities for your assistance in volume control problems.

Bulletin M.I. is now ready for those who inquire for it.

### D'Arcy Laboratories

160 A. East Illinois Street Chicago, Illinois

### Beat-Frequency Oscillator



Type 413-B Beat-Frequency Oscillator  
Price \$175.00

Any frequency in the band between 50 and 10,000 cycles per second is available by setting the single control of this beat-frequency oscillator. Operated by batteries, it is readily portable and makes a practically indispensable instrument for the laboratory engaged in measurements and other experimental work at audio frequencies.

A request on your business letterhead will bring you a catalog description of this and other General Radio laboratory instruments. Please ask for Catalog F-A.

#### GENERAL RADIO COMPANY

Offices Laboratories Factory

CAMBRIDGE A,

MASSACHUSETTS

# Microphones

HOME RECORDING » » »

PUBLIC ADDRESS » » » »

STANDARD BROADCAST

## Kellogg Switchboard and Supply Company CHICAGO

# VARIABLE

ADJUSTABILITY and PERMANENCE  
*Effectively Combined for*  
STABLE CIRCUIT OPERATION



Advances in radio receiver and oscillator circuits have necessitated the development of a new variable condenser of an order of excellence far exceeding the elementary devices of the early ganged tuning condenser era.

The DeJur-Amsco Variable Condenser is designed to fulfill the following requirements of the so-called "fixed variable" capacitor in modern radio frequency and superheterodyne circuits:

1. Adequate variation in capacity.
2. Adequate total capacity.
3. Permanence of adjustment, preferably secured by locking.
4. Rapid but micrometer adjustment.
5. High electrical efficiency.
6. Adaptability to production specifications and methods.
7. Absolute guarantee against mechanical or electrical fault requiring replacement.

Write for Booklet Giving Complete Specifications

## DeJUR-AMSCO CORP.

Variable Condensers—Power Rheostats  
95 Morton Street New York City

### THERMO COUPLES IN VACUO FOR USE WITH RAWSON MILLIVOLT and MICROAMMETERS



Measuring currents from .0001 amp. to 1 amp. of any frequency including radio frequency. Thermo Couples in air up to 10 amp.

### RAWSON ELECTRICAL INSTRUMENT CO. INCORPORATED 1918 95 WINDSOR ST., CAMBRIDGE, MASS.

Branch Office: 81 Seventh Ave. New York City  
Midwestern Representative  
Earl N. Walker, Daily News Bldg., Chicago, Ill.  
Specialists In High Sensitivity Meters



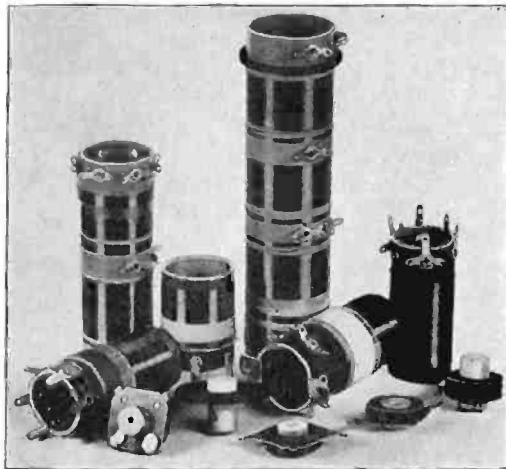

# RADIO FREQUENCY COILS

of every type and description, produced under laboratory control to your exact specifications—not approximately correct, but exact. And at prices below those of ordinary coils.

Special coils to match Super-heterodyne condensers by Precise and Radio Condenser Company.

*"Accuracy is of primary importance"*

## 175-180 Kc AMPLIFIERS

A single unit, 5 1/4" x 1 3/4" x 2 3/8", containing individually shielded, two intermediate and one filter transformer, and six tuning condensers for adjustment to the desired frequency. All terminals on bakelite block on base, or grid leads from top if desired. Completely avoids assembly troubles—the most compact unit available.

Samples to your specifications, complete particulars and prices gladly supplied upon request.

### AUTOMATIC WINDING COMPANY

W. W. BOYD & CO.,  
9 So. Clinton St., Chicago

NEWARK, N. J.

B. L. MOORE  
191 Starin Ave., Buffalo

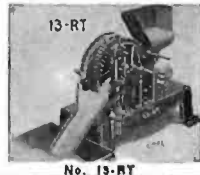

### TIPLESS EXHAUST TUBE BENDER-EISLER METHOD

AVOID PATENT SUITS  
SEND FOR BULLETIN 7

EISLER ELECTRIC  
700 South 13th Street,  
NEWARK, N. J.

## CONDENSER PAPER

182 Cornelson Ave. — Mills at — Newark Ave.  
Jersey City, N. J. Elizabeth, N. J.

PETER J. SCHWEITZER, Inc.,

200 Fifth Ave. New York

### MICROPHONES

All kinds \$10.00 to \$350.00

For—Home Recorders, Type S. G. P.	List \$10.00
For Public Address Work, etc., Type S. S.	List \$25.00
Standard Broadcast Model, Type B. G. M.	List \$45.00
Standard Broadcast Model, Type S. G. S.	List \$62.50
Condenser Type for film and record recording, Type S. G. C.	List \$250.00
Also desk, floor stands, covers and etc.	Expert Microphone Repairs.

#### SILVERLEAF MICROPHONE COMPANY

2658 Pasadena Ave., Los Angeles, Calif.  
Chicago Distributors—Duncan & Sternhold—Radio Sales, Inc.  
1507 Michigan Ave., So. Representatives wanted

## Bauch-International Compound High Vacuum Pumps

We manufacture all sizes of High Vacuum Pumps from 1-200 cu. ft. per min. All pumps tested at 1/2 micron before leaving factory. Write for details.

INTERNATIONAL MACHINE WORKS, Inc.  
527-529 Thirty-Second St., Union City, New Jersey

## COILS

Choke-Impedance — — — Magnet-Transformer

### TRANSFORMERS

Audio—B—Power Unit—Broadcast Station—Output  
Filament Heating—Power—Stepdown

Have us quote to your specification

POWER TRANSFORMER CO., 145 W. 22nd St., New York City

## CLAMP NAILS

For All Mitered Joints

Send for FREE Samples and Catalog

A nail good that the Super Engineer can use and the handy worker can use. It is made of the finest steel and is produced in a special way to give the widest clampage.

Made in U.S.A.  
Patented  
1928

**CLAMP NAIL CO.**  
6810 Palmer St.,  
CHICAGO, ILL.



## GEARS

In Stock—Immediate Delivery

Gears, speed reducers, sprockets, thrust bearings, flexible couplings, pulleys, etc. A complete line is carried in our Chicago stock. Can also quote on special gears of any kind. Send us your blue prints and inquiries.

Write for Catalog No. 200

**CHICAGO GEAR WORKS**

789-773 W. Jackson Blvd., CHICAGO, ILL.

# WIRE

ALPHA

Quality wire for every type of hook-up

"Alpha" a slip back braided hook-up wire made under a patented process.

Alpha "HITENSION" Wire (colored Rubber)

BARE-TINNED-ENAMELED-RUBBER COVERED

—CABLES TO SPECIFICATION—

**ALPHA WIRE CORPORATION**  
60 Howard St., New York City

ALPHA

# LAMINATIONS

for Audio & Power Transformers  
SPECIALIZED METHODS—YEARS OF EXPERIENCE  
Wide Variety of Stock Standard Sizes  
Dimension and Price Sheets on request

We Also Make  
PERMANENT MAGNETS—DIES—TOOLS—  
METAL STAMPINGS  
Facilities for prompt service

**Thomas & Skinner Steel Products Co.** 1100 to 1120 E. Twenty-Third St. INDIANAPOLIS, IND.

WE offer to manufacturers interested in  
**EXPORT**  
the services of a dependable organization, well established in the entire foreign field  
**AD. AURIEMA, INC.**  
Manufacturers' Export Managers  
116 Broad Street, New York, N. Y.

We Cater to Laboratories—Broadcasting Stations—Talking Movies, Etc. Parts for any and every item you may need always on hand. Call on us for your requirements

**LEEDS**  
*The Home of RADIO*

45 VESEY STREET, NEW YORK CITY

**FELT**  
For Every Radio Purpose  
AETNA FELT COMPANY  
200 Centre Street . . . New York City

**DeWALD**  
Licensed by R.O.A. A.C. and D.C. Midget Receivers Write for complete details. Licensed by R.O.A. PIERCE AIRO, INC. 115-117 Fourth Ave., New York City

**Portable Condenser Microphones**



2P 2 stage plate output... List \$110.00  
2C 2 stage 200 ohm output List 125.00  
Uses 2 type 230 low drain tubes.  
3P 3 stage plate output... List \$125.00  
3C 3 stage 500 ohm output. List 150.00  
Uses 2 240 and 1 112-A tube.

These prices for type "A" unit.  
For type "B" unit add \$40.00 each list. Standard finish is black and gold. Prices include tubes and 20 ft. cord. Interesting dealer proposition.

**Astatic Microphone Laboratory**  
21 Olive Street  
YOUNGSTOWN, OHIO

**ANNOUNCEMENT!**

The Daven Company announces the purchase of the assets and good-will of the Superior Resistor Corp. of Newark, N. J.

Write for New Catalogs No. 331 and 431 containing important engineering data.

SUPER-DAVOHM SUPEROHM DAVOHM

**THE DAVEN COMPANY**  
Resistor Specialists  
156 Summit St. Newark, N. J.

**RADIO APPARATUS TESTING**



Life tests and characteristics of vacuum tubes. Calibration of all kinds of instruments. Determination of inductance and capacitance at various frequencies. Resistance measurements, motor tests, magnetic tests, etc.

**Electrical Testing Laboratories**  
80th St. and East End Ave.  
New York



**UNIVERSAL MICROPHONES**

NEW MODEL "LL" MICROPHONE SUPREME



All steel 2-button broadcast carbon microphone; turned from solid bar, ground to .001 accuracy. Truly damped alloy diaphragm, exact proper hardness; pure gold contacts. Standard 200 ohm per button. 1 1/2 in. diameter by 1 1/2 in. thick. Reproduces 30 to 7000 cycles. Made in three degrees of sensitivity.

**UNIVERSAL MICROPHONE CO., Ltd.**  
1163 Hyde Park Blvd.  
INGLEWOOD CALIF.

Other models \$5 to \$350. Also cables, plugs, transformers, mountings, stands, etc. Expert microphone repairs.

**FOR BETTER BUSINESS  
VISIT NEW YORK**

★ **2<sup>50</sup>** daily ★

... secures a fine room and bath ...  
others at \$3<sup>00</sup> and \$3<sup>50</sup>

**AT ONE OF NEW YORK'S BEST HOTELS**

*The* **BRISTOL**

**48<sup>th</sup> ST. EAST OF B'WAY ▲▲ NEW YORK CITY**  
OWNERSHIP MANAGEMENT ▲▲ T. ELLIOTT TOLSON, Pres.

**HOTEL  
STRATHMORE**

Away from the noise and confusion of Downtown... Yet only six minutes from the center of Business Shopping and Theatres

350 LARGE AIRY ROOMS EACH WITH BATH

**RATES**  
\$2.00 and \$3.00 Single  
\$3.00 and \$4.00 Double  
Special weekly rates \$10.00 to \$15.00

EXCEPTIONALLY FINE FOOD  
Lunch --- 50¢  
Dinner -- 50¢-75¢

H. E. SELLNER  
Resident Manager



ATKINSON SERVICE

ALEXANDRINE WEST NEAR WOODWARD  
**DETROIT**

OVERLOOKING BEAUTIFUL JUNEAU PARK AND LAKE MICHIGAN

**THE  
Plaza  
APARTMENT HOTEL**

*A Dignified Place of Residence for Permanent and Transient Guests*

FURNISHED APARTMENTS AND HOTEL ROOMS FOR TRANSIENTS

*Ideal for women traveling alone*

Personal Attention by  
**MILTON E. MAGEL**

ON CASS AT EAST STATE STREET  
**Milwaukee**

800 APARTMENTS  
300 ROOMS



**NICKEL  
WIRE CLOTH**

for the  
**RADIO TUBE INDUSTRY**

Any mesh woven accurately to your specifications.  
**"CLEVELAND"**

Wire Cloth renowned for its Uniformity, its Superiority,  
its Durability.

*Advise us of your Requirements*

**The Cleveland Wire Cloth & Manufacturing Co.**  
3571 E. 78th Street, CLEVELAND, Ohio

**FLAT RESPONSE CURVES**  
*for Exacting Requirements*

Recent Audio Frequency and Special Impedance Matching Transformers give the *Flat Response Curves* required by Broadcast Stations and Laboratories, and in Speech Transmission.

Special Transformers, made in the U. S. A., can be shipped within 48 hours from receipt of order.

**BETTER AMPLIFICATION** . . . for Educational and particular commercial requirements, is furnished by Ferranti Amplifiers.

*Write for quotations and complete particulars.*

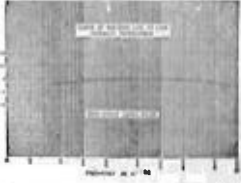

*Typical Curves of 400 Ohm line to line transformers*

**FERRANTI, Inc.** 130 West 42nd Street  
New York

The Home Hotel of New York  
Homelike in service, appointments and location . . . away from noise and congestion, yet but a few minutes from Times Square . . . garage facilities for tourists.

Room and Bath from \$3 single, \$4 double—506 rooms  
Home folks will like this hotel

HOTEL

**BRETTON HALL**  
BROADWAY at 86th STREET  
NEW YORK

**Ellis**  
**MICROPHONES**  
for **TONE**



Model 30N

ELLIS Microphones are world-famous for their true natural TONE Quality. ELLIS TONE Quality is attained by a combination of several features not to be found in any other microphone. You should have our catalog sheets with detailed specifications on file. Write today.

Export: Simons, 25 Warren St., N. Y. Cable: "Simotrice."

**ELLIS ELECTRICAL LABORATORY**  
117 W. MADISON ST. Sales Corporation CHICAGO

**BARE AND TINNED  
COPPER WIRE**

*For All Purposes  
Fine Sizes Our Specialty*

**SPARGO WIRE COMPANY**  
ROME, NEW YORK  
Established 1885

**Stampings**  
**Pressed Metal for Radio Industry**

Steel, Aluminum, Copper, Brass and all Alloys  
Send Inquiries and Drawings

**METAL SPECIALTY CO.** 1533 Riverside Dr.  
Cincinnati, Ohio

NOW OPEN  
*The New York*  
*The HOTEL*  
**GOVERNOR CLINTON**

*Opposite Penn. R. Station  
New York's new hotel truly expressive of  
the greatest city. 1200 pleasant rooms  
each with Servidor, bath, circulating  
ice water and radio provisions.*

ROOMS from \$3.00



31<sup>ST</sup> STREET 7<sup>TH</sup> AVENUE

**BETTER RADIO PERFORMANCE**  
with **AMPERITE**

AMPERITE automatically regulates line voltage fluctuations. Improves tone, protects tubes and other equipment, reduces fire service. Easily installed in 5 minutes without chassis changes. Makes your careful laboratory specifications mean something in better set performance.



**AMPERITE Corporation**  
501 BROADWAY, NEW YORK

**AMPERITE**  
*Self-Adjusting*  
**LINE VOLTAGE CONTROL**

Write Dept.  
RE-3 for full  
information  
and AM-  
PERITE set  
chart.

**Rocke International Electric Corp.**  
15 Laight Street, New York

*Export sales managers for nationally  
known radio manufacturers.*

▲ ▲ ▲ ▲ ▲

# DEPENDABLE QUALITY — UNIFORMITY SERVICE

ON  
WAXES — & — MELTABLE  
INSULATING and WEATHER-  
PROOFING COMPOUNDS

WAXES—All kinds.

IMPREGNATIONS—Condensers, Coils, Rubber-Covered and Weather-Proofed Wire, Telephone and Electrical Cables, Etc.

SEALING COMPOUNDS—Coils, Condensers, Batteries (Wet & Dry), Pot Heads, Cables, Wiring Devices and Specials.

FINISHING—All grades of Weather Proof and Rubber-Covered Wire.

SPECIAL COMPOUNDS



35th St. & Maplewood Ave.  
Chicago, Ill.

"For over 35 yrs."

# RADIO WIRE

TO RADIO ENGINEERS—

Send us your specifications or blue-prints for Assemblies, Cables and Remote Control Cords—

for

Midget and all other Radio Sets—using GUTTA PERCHA, Rubber Insulated or wire constructed to specifications.

For Radio Hook-up—

GUTTA PERCHA wire is used extensively as it affords free stripping, easy push back and is impervious to moisture. Made exclusively by us.

Aerial Wire, Insulated—

Gutta Percha, Braided and Weatherproof Impregnated.

For efficient reception—sample upon request.

Also—

Shielded, armored and other type wires for Radio Use. Let us supply details.

THE HOLYOKE COMPANY, Inc.  
621 BROADWAY, NEW YORK CITY

## INDEX OF ADVERTISERS

<b>A</b>		<b>F</b>		<b>J</b>	
Acheson Oildig Co. . . . .	67	Fansteel Products Co., Inc. . . . .	51	Jenkins & Adair, Inc. . . . .	60
Ad. Aurlens, Inc. . . . .	63	Ferranti, Inc. . . . .	65	Johnson & Johnson . . . . .	68
Aerovox Wireless Corp. . . . .	40	Formica Insulation Co. . . . .	1	Kellogg Switchboard & Supply Co. . . . .	61
Aetna Felt Co. . . . .	62	Frost, Herbert H., Inc. . . . .	G. 7	Leeds Radio Co. . . . .	63
Alpha Wire Corp. . . . .	62			Mallory & Co., P. R. . . . .	15
American Felt Co. . . . .	55	<b>G</b>		Metal Specialty Co., The . . . . .	65
American Transformer Co. . . . .	68	General Cable Corp. . . . .	14		
Amperite Corp. . . . .	65	General Electric Co. . . . .	20	<b>N</b>	
Amplou Corp. of America . . . . .	67	General Etching & Mfg. Co. . . . .	59	Nat'l Elec. Prod. Corp. . . . .	9
Arcturus Radio Tube Co. . . . .	49	General Mfg. Co. . . . .	57	Newark Wire Cloth Co. . . . .	55
Astatic Microphone Lab. . . . .	63	General Industries Co., The . . . . .	39		
Automatic Winding Co. . . . .	62	General Radio Co. . . . .	61	<b>P</b>	
				Parker-Kalon Corp. . . . .	5
<b>B</b>		<b>H</b>		Pierce Airo, Inc. . . . .	63
Bakelite Corp. . . . .	Back Cover	Hanwarlund Mfg. Co. . . . .	67	Powell & Co., R. C. . . . .	56
		Holyoke Company, Inc., The . . . . .	66	Power Transformer Co. . . . .	52
<b>C</b>				<b>R</b>	
Candy & Co. . . . .	60	<b>I</b>		Radio Mfrs. Association . . . . .	10
Cardwell Mfg. Corp., Allen D. . . . .	60	Inca Mfg. Division . . . . .	9	Radio Products Co., The . . . . .	60
Central Radio Laboratories . . . . .	8	Int'l Machine Works, Inc. . . . .	62	Rawson Elec. Inst. Co. . . . .	61
Central Scientific Co. . . . .	Second Cover	Int'l Resistance Co. . . . .	3	Roche Int'l Elec. Corp. . . . .	65
Chicago Gear Works . . . . .	62			Roebbling, J. A., Nunn Co. . . . .	67
Clamp Nail Co. . . . .	62	<b>J</b>		Rola Co., The . . . . .	13
Cleveland Wire Cloth & Mfg. Co., The . . . . .	65	Johnson & Adair, Inc. . . . .	60		
Condenser Corp. of America . . . . .	56	Johnson & Johnson . . . . .	68	<b>S</b>	
				Schweltzer, Peter J., Inc. . . . .	72
<b>D</b>		<b>K</b>		Scovill Mfg. Co. . . . .	16
Daven Company, The . . . . .	63	Kellogg Switchboard & Supply Co. . . . .	61	Shalcross Mfg. Co. . . . .	60
DeForest Radio Co. . . . .	19			Silverleaf Microphone Co. . . . .	62
DeJur-Amsco Corp. . . . .	61	<b>L</b>		Soreng Manegold Co. . . . .	57
Duggan Elec. Mfg. Co. . . . .	Third Cover	Leeds Radio Co. . . . .	63	Sprague Wire Co. . . . .	65
Dublier Condenser Corp. . . . .	11			Sprague Specialties Co. . . . .	47
		<b>M</b>		Synthane Corp., Inc. . . . .	12
<b>E</b>		Mallory & Co., P. R. . . . .	15		
Easton Coil Company . . . . .	67	Metal Specialty Co., The . . . . .	65	<b>T</b>	
Eisher Electric Corp. . . . .	62			Thomas & Skinner Steel Products Co. . . . .	63
Electrical Testing Labs. . . . .	63	<b>N</b>		Thompson-Bremer & Co. . . . .	68
Elkon Division . . . . .	15	Nat'l Elec. Prod. Corp. . . . .	9	<b>U</b>	
Ellis Elec. Laboratory . . . . .	65	Newark Wire Cloth Co. . . . .	55	Universal Microphone Co., Ltd. . . . .	63
Erie Resistor Corp. . . . .	17			<b>W</b>	
				White Dental Mfg. Co., The, S. S. . . . .	50
				Wireless Egert Eng., Inc. . . . .	60
				<b>Z</b>	
				Zapon Co., The . . . . .	58



# AMPLION



TYPE Y M  
\$65.00  
Less Stand



TYPE H M  
\$25.00



TYPE J M  
\$25.00  
Less Stand

Transverse Current

## MICROPHONES

Write for 20-page catalogue and price list describing microphones, microphone amplifiers, 50-watt power amplifiers, giant dynamic air column units, exponential horns, synchronous and non-synchronous turntables, and complete panel mounted equipment for schools, hotels, hospitals, parks, skating rinks, steamships, airplanes, auditoriums, theatres, etc.

Centralize Responsibility for the Success of Your Installations by Purchasing All the Parts From One Source.

**Amplion Corporation of America**  
133 W. 21st St., New York City

## ANNOUNCING

Two New Departments of the  
**EASTON COIL COMPANY**  
ready for the production of

### TRANSFORMERS AND WIRE-WOUND RESISTANCES

These two new products will maintain the same high standards of uniform quality and enduring performance that have been responsible for the outstanding success of EASTON Coils.

**NOW EASTON MAKES 3 GREAT PRODUCTS**

EASTON COILS	EASTON WIRE-WOUND RESISTANCES	EASTON TRANSFORMERS
-----------------	----------------------------------	------------------------

Our Engineering Department will be pleased to cooperate with you in your design problems. All information will be held in strict confidence. Send your specifications. Samples and quotations furnished promptly.

**EASTON COIL COMPANY**  
EASTON, PA.

P. O. Box 237





**TONE CONTROL**

is not a matter of muffling the treble to emphasize the bass.

It is a delicate blending of the two, accomplishable with sensitive resistance elements only, as produced by "Aquadag" Colloidal-Graphited Water.

Send for Technical Bulletin No. E 11.1

## ACHESON OILDAG CO.

PORT HURON, MICH.

Trademark "AQUADAG" Reg. U. S. Pat. Off.

### A New HAMMARLUND CONDENSER for Tuning Intermediate-Frequency Transformers



**STRONG** Isolantite base designed for mounting inside of the intermediate transformer shield. Adjustment screws for precise tuning of both transformer circuits.

Self-aligning, phosphor bronze, adjustable spring plates, and the highest grade mica insulation. Plates firmly anchored by double rivets with shock-absorbing guard. Condenser will not change in resistance or capacity under any condition of humidity, temperature or vibration. Slotted gripper solder-dipped terminals.

Efficiency of design proved in actual service. Materials the best obtainable. Thoroughly tested for break down.

Three ranges obtainable in single (code I C S) or dual (code I C D) models. 10 to 70 mmf.—70 to 140 mmf.—140 to 220 mmf.

Mail coupon for sample and technical data.



**Hammarlund**  
FINE CISION  
PRODUCTS

For Better Radio

Write for sample and technical data on  
HAMMARLUND MFD. CO.  
221 3rd St., 25th St., W.  
New Haven, Conn.  
Transformer Tuning Condensers

Name \_\_\_\_\_  
Address \_\_\_\_\_  
City \_\_\_\_\_  
State \_\_\_\_\_  
Phone \_\_\_\_\_  
RE-3

# AMERTRAN POWER AMPLIFIERS

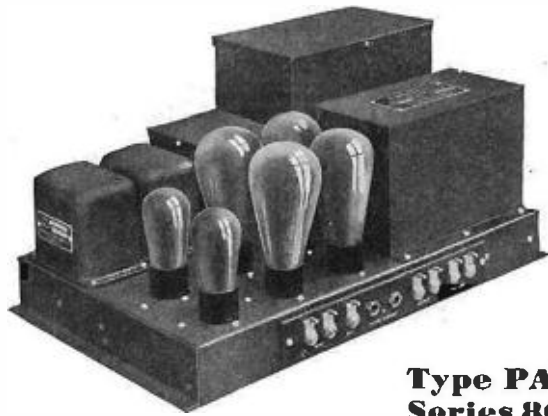

**Type PA,  
Series 80**

An economical means of obtaining flawless reproduction of sound in large volume is available in a new series of Amertran Power Amplifiers, the result of months of laboratory experimentation and exhaustive field tests.

There are four sizes in the new Series 80, one to fill every requirement. The big Type PA-86, shown in the illustration, will flood an auditorium with a full volume of music or speech without distortion. Smaller models are made for installations in restaurants, clubs, dance halls, schools and homes — wherever exceptional fidelity of reproduction at high volume is desired.

The mounting and construction is such that they are installed easily, with no bothersome wiring and connections, and are proof against tampering or damage. Simple controls and ease of portability are added features that contribute to the popularity of Amertran Power Amplifiers whose record of performance has won the distinction of being considered The Standard of Excellence for Audio Reproduction.

*Licensed under patents of R. C. A. and Associated Companies*



**AMERICAN TRANSFORMER COMPANY**  
178 Emmet Street, Newark, N. J.

For complete description and information contained in Bulletin 1079 send us the coupon below:

AMERICAN TRANSFORMER COMPANY 178 Emmet Street, Newark, N. J.	RE-4-31
Gentlemen: Send me Bulletin 1079 with complete description of Type PA, Series 80 Amertran Power Amplifiers.	
Name .....	
Street & No. ....	
City .....	State .....

*Now....*

## A NEW PATENTED CONSTRUCTION PRINCIPLE



U. S. PATENT NO. 1776708

EVERLOCK washers and terminals have a new patented locking feature which is the secret of the tenacious grip and the positive lock.

EVERLOCK steel washers are coated after fabrication to prevent rusting.

EVERLOCK terminals are hot solder coated which makes them easy to solder and speeds up production.

Our manufacturing methods make it possible to quote prices in keeping with present economy programs.

We manufacture

EVERLOCK washers

EVERLOCK terminals

Eyelet terminals

Plata terminals single or double

All are hot solder coated after fabrication

Special terminals made to order

Send us your specifications

**THOMPSON-BREMER & Co.**  
1642 West Austin Ave. .. Chicago

WASHERS  
*Everlock*  
TERMINALS

WILLIAMS PRESS, INC., NEW YORK—ALBANY



**DONGAN**

## Build a Set That Backs Up Every Dollar of your Advertising Budget

### Transformers for Replacements in Old Sets

*Those who are interested in Set Rejuvenation will be interested in our new Replacement Transformer Booklet. A copy sent upon request.*



No. 6952

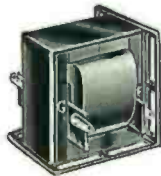

No. 5140

Advertising is not short-lived. A newspaper advertisement is not dead the next day—as it may appear at first thought.

First you give your product a name. To induce sales you claim merit. Then, by newspaper, magazine and bill board you flash your name and message to the world. Your money seems to have been spent wisely. Sales grow and the name of your product becomes widely known.

But—does the product stand the test of public approval?

Money spent to advertise a first-class product is very well invested. Good will grows and in turn creates new sales for new Sets bearing your name.

Buy the finest Transformers you can get for your product. Insure your name for sales next year too.

### For Your New 1931 Designs

*Radio Set Manufacturers are invited to utilize the facilities of the Dongan Laboratories which have been engaged in radio Research and Development for 19 years.*

**Dongan Electric Mfg. Co.**  
2991-3001 Franklin St., Detroit



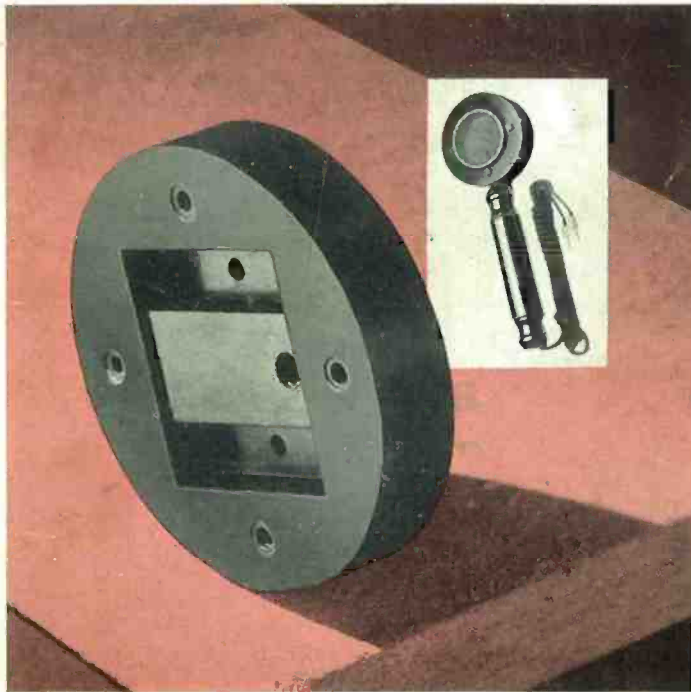

Bakelite Molded part  
used in microphone  
made by Amplion  
Corp., New York

## Accurately formed of Bakelite Molded at less than half cost

The insulation block upon which the sensitive elements of a microphone are mounted, must possess high insulation value and great rigidity and strength. It must also resist moisture and be free from swelling or shrinkage. In Bakelite Molded the Amplion Corp. found a material that possessed all of the required properties. In addition, the cost of the Bakelite Molded part was less than half that of the one made of another material. This saving was effected because the Bakelite Molded part was completely formed in one press

operation, eliminating the assembly charges required when another material was used.

In the fields of radio and electronics, Bakelite Materials, molded, laminated and varnished, are providing insulations that retain their value indefinitely. They are moisture resistant, and do not shrink or swell. Insulation properties are unimpaired by age or use. Our Booklets 38M, 38L and 38V contain much interesting information and will be mailed promptly on request.

**Bakelite Engineering Service**—We manufacture a wide variety of Bakelite resinoid molding materials, varnishes, lacquers, enamels, cements, and other products. Twenty-one years experience in the development of these materials for industrial and other uses provides a valuable background for the cooperation offered by our engineers and laboratories.

**BAKELITE CORPORATION**, 247 Park Avenue, New York    **CHICAGO OFFICE**, 635 West Twenty-second Street  
**BAKELITE CORPORATION OF CANADA, LIMITED**, 163 Dufferin Street, Toronto, Ontario

# BAKELITE

REGISTERED U.S. PAT. OFF.



The registered trade marks shown above distinguish materials manufactured by Bakelite Corporation. Under the capital "B" is the numerical sign for infinity, or unlimited quantity. It symbolizes the infinite number of present and future uses of Bakelite Corporation's products.

## THE MATERIAL OF A THOUSAND USES